

Planning Justification Report

5357 & 5377 Elcho Road

Expansion of Agriculture-Related Commercial Use

West Lincoln, ON

August 2024

**Upper Canada Consultants
30 Hannover Drive
St. Catharines, ON L2W 1A3**



UCC FILE NO. 2189

Report Contents

PREFACE	2
DESCRIPTION AND LOCATION OF THE SUBJECT LANDS.....	3
THE PROPOSED DEVELOPMENT.....	9
REQUIRED APPLICATIONS	12
REQUIRED STUDIES AND REPORTS	13
PROVINCIAL PLANS	14
PLANNING ACT (R.S.O. 1990).....	14
2020 PROVINCIAL POLICY STATEMENT.....	20
PROVINCIAL GUIDELINES FOR PERMITTED USES IN ONTARIO’S PRIME AGRICULTURAL AREAS.....	25
2020 GROWTH PLAN FOR THE GREATER GOLDEN HORSESHOE	27
NIAGARA OFFICIAL PLAN (2022)	29
Chapter 4 – Competitive Region	29
Chapter 3 – Sustainable Region	35
TOWNSHIP OF WEST LINCOLN OFFICIAL PLAN.....	36
Section 4 – Agricultural Land Use Policies	36
Section 8 – Heritage Conservation.....	44
Section 10 – Natural Environment.....	45
Section 14 – Infrastructure and Transportation	45
Section 18 – Implementation.....	46
TOWNSHIP OF WEST LINCOLN ZONING BY-LAW (By-law No. 2017-70).....	51
Table 1: Zoning Compliance Table – Service Commercial (C3) Zone – 5377 Elcho Road (After Merged)	53
Table 2: Zoning Compliance Table – Agricultural (A) Zone – 5357 Elcho Road (Dwelling and Farm).....	56
PLANNING POSITION.....	57

Appendix I – Preliminary Site Plan prepared by Upper Canada Consultants

Appendix II – Pre-consultation Meeting Notes

Appendix III – Draft Zoning By-law Amendment

Appendix IV – Preliminary Consent Sketch

Appendix V – Preliminary Grading Plan

PREFACE

Upper Canada Consultants has been retained by NGF Property Inc. to prepare a Planning Justification Report pertaining to applications for Zoning By-law Amendment and Consent to Sever related to lands known municipally as 5357 and 5377 Elcho Road in the Township of West Lincoln, within the Regional Municipality of Niagara.

The owner of 5377 Elcho Road is proposing the expansion of their business operations northward onto a portion of 5357 Elcho Road which is currently used for agriculture cultivation. The developed portion of the property is zoned Service Commercial (C3) and contains agriculture-related commercial uses that sell and repair agricultural equipment, field and drainage materials and septic and water systems. Their current outdoor storage yard is no longer adequate to meet the temporary inventory storage needs of the business and an expansion is required. The total area to be added to the use is 2.03 hectares (5.01 acres) which would be added to the property through a Consent (boundary adjustment) application.

To facilitate the severance and permit the expansion of the existing agriculture-related commercial use, a portion of the zoning on 5357 Elcho Road is proposed to be amended from Agricultural (A) to Service Commercial (C3), consistent with the Zoning of the existing businesses located at 5377 Elcho Road. A site-specific provision for outdoor storage will be applied to the entirety of the consolidated agricultural related commercial property.

This report evaluates how the required Zoning By-law Amendment and Consent applications satisfy the applicable requirements of the Planning Act, are consistent with the Provincial Policy Statement (2020) and conform to the relevant policies of the Growth Plan for the Greater Golden Horseshoe (2020), Niagara Official Plan (2022) and West Lincoln Official Plan (2015).

This Report should be read in conjunction with the following reports and materials:

- Preliminary Site Plan prepared by Upper Canada Consultants
- Preliminary Grading and Drainage Plan prepared by Upper Canada Consultants
- Preliminary Severance Sketch prepared by Rasch and Hyde Land Surveyors
- Draft Zoning By-law Amendment prepared by Upper Canada Consultants
- Stage 1 and Stage 2 Archeological Assessments prepared by Detritus Consulting

DESCRIPTION AND LOCATION OF THE SUBJECT LANDS

The Zoning By-law Amendment application pertains to lands known municipally as 5357 Elcho Road in the Township of West Lincoln, within the Regional Municipality of Niagara. The subject lands are legally described as PT S1/2 LT 13 Con 2 Gainsborough Pt 2 30R2450 T/W RO395283; West Lincoln. A context map showing the location of the property and portion to be rezoned is provided below in **Figure 1**.

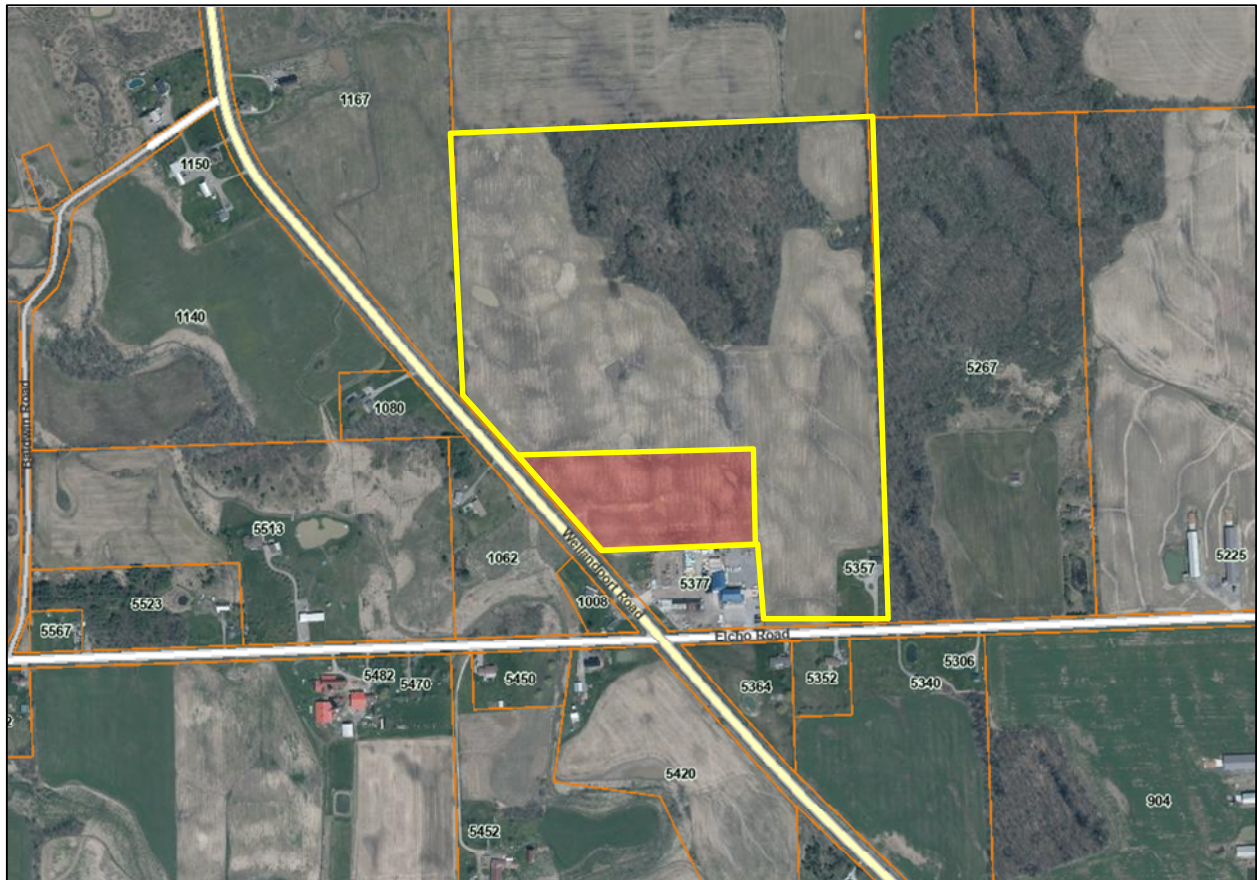

Figure 1 - Context Map – 5357 Elcho Road, West Lincoln – Cropped from Niagara Navigator

The subject lands are approximately 32.69 hectares in area and have approximately 171.64 metres of frontage along Elcho Road. The portion of the property to be severed and have the zoning amended measures 2.03 hectares in area. The portion of the subject lands to be conveyed to 5377 Elcho Road has historically been used for agricultural purposes and does not contain any structures or any municipal or private services.

Existing Uses

5357 Elcho Road

The property known municipally as 5357 Elcho Road currently contains a single detached dwelling and detached garage on the southeast corner of the property. The balance of the lot contains manicured lawn, agricultural fields and a wooded area containing a provincially significant wetland.

5377 Elcho Road

The property known municipally as 5377 Elcho Road is currently used for commercial purposes and is zoned “Service Commercial” (C3). The following businesses operate from the site:

- Excavation Company (Anthony’s Excavating)
- Ontario Agra Piping (Agricultural Pipe and Tile vendor)
- Kor Rentals (Farm Equipment Rental and Repairs)
- Enercon (Green Energy Maintenance for Windmills)

The expansion lands are intended to be utilized by Ontario Agra Piping and Kor Rentals, which require additional lands for temporary material and equipment storage prior to being sent to site for installation.

Adjacent Land Uses

Adjacent land uses include the following:

North: Agricultural Lands, Provincially Significant Wetland

West: Regional Road 27 (Wellandport Road), Agricultural Lands, Residential Dwellings

South: Existing Commercial Operation, Residential Dwellings, Agricultural Lands

East: Residential Dwellings, Agricultural lands

Land Use Designations and Zoning

The subject lands are located within the Prime Agricultural Area and are therefore subject to relevant policies within the 2020 Provincial Policy Statement, 2020 Growth Plan for the Greater Golden Horseshoe, 2022 Niagara Official Plan and 2015 Township of West Lincoln Official Plan.

The subject lands are not located within the Greenbelt Plan Area or the Niagara Escarpment Plan boundary and therefore those plans and policies do not apply to the applications.

The subject lands are designated as Prime Agricultural Lands on Schedule F – Agricultural Land Base of the 2022 Niagara Official Plan.

Schedule B1 of the Township of West Lincoln Official Plan designates both 5357 and 5377 Elcho Road as Good General Agricultural.

Zoning By-law 2017-70 delineates 5357 Elcho Road as being Zoned Agricultural (A), Environmental Protection (EP) and Environmental Conservation (EC), and 5377 Elcho Road as Service Commercial (C3).

Natural Heritage Features

As shown on the Niagara Region’s online Natural Heritage Mapping Viewer, 5357 Elcho Road contains a mix of natural heritage features at the northern end of the property. These features include a provincially significant wetland, significant woodland, watercourse and potential natural heritage corridors.

The proposed expansion is for the commercial business is located at the southern end of the property and greater than 120 metres from these features.

Site Photographs

Pictures of both properties are provided in **Figures 2 to 7** on the following pages for additional site context.



Figure 2 - Existing Office and Retail Space (5377 Elcho Road)



Figure 3 - Outdoor Storage of Pipes and Landscape Materials



Figure 4 - Outdoor Storage of Tanks



Figure 5 - Equipment Parking



Figure 6 - Expansion Lands with Crops, looking North



Figure 7 - Existing Access to 5377 Elcho Road from Wellandport Road

THE PROPOSED DEVELOPMENT

NGF Property Inc. is proposing to expand the existing commercial operation located at 5377 Elcho Road by adding 2.03 hectare contiguous to the northern limit of the existing property from 5357 Elcho Road. The expansion area will be utilized for the storage of agricultural materials and equipment. No structures are proposed within the expansion area, just graded lands for storage and a portion of lands for a Stormwater Management Facility.

The existing land uses at 5377 Elcho Road will remain in operation. No new buildings are proposed.

As shown in **Figure 8** on the following page, and **Appendix IV**, the provisional severance sketch prepared by Rasch and Hyde shows the existing commercial business at 5377 Elcho Road as Part 1, the proposed expansion lands as Part 2 and the remnant lands of 5377 Elcho Road as Part 3.

Figure 9, being the preliminary Grading Plan, shows the proposed stormwater management pond and initial grading concept.

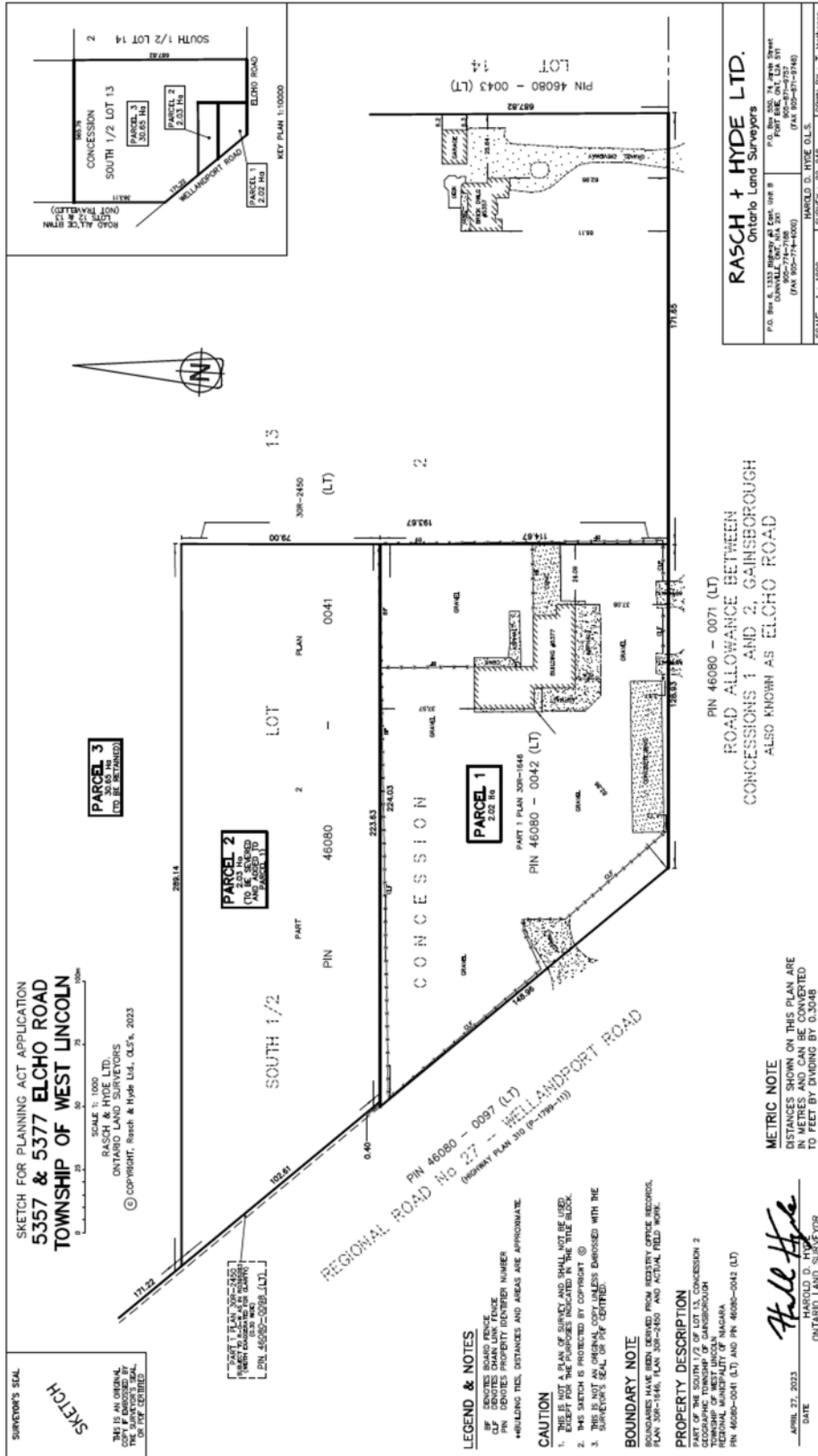

Figure 8 - Preliminary Severance Sketch

REQUIRED APPLICATIONS

Pre-consultation meetings pertaining to the applications were held on April 16, 2020 and May 3, 2023. As per Township staff, applications for Zoning By-law Amendment, Consent to Sever, and Site Plan Approval are required to facilitate the expansion of the commercial use as envisioned by the applicant.

As outlined by the review agencies (Township of West Lincoln, Niagara Region, and Niagara Peninsula Conservation Authority), complete application submission requirements include:

- Planning Justification Report
- Minimum Distance Separation Calculation
- Private Servicing Plans
- Preliminary Site Plan

Copies of the noted Pre-consultation Agreements are provided within **Appendix II** to this report.

Zoning By-law Amendment

To facilitate the expansion of the existing agriculture-related commercial uses, a Zoning By-law Amendment is required to zone a portion of the subject lands from Agricultural (A) to Service Commercial (C3).

A copy of the Draft Zoning By-law Amendment is included as **Appendix III** to this report.

Consent to Sever

Subject to Zoning Approval, the applicant will then be required to apply for a severance to add the lands from 5357 Elcho Road to 5377 Elcho Road. The Zoning By-law Amendment is required to establish the minimum required Lot Area for the remnant parcel.

Site Plan Approval

Site Plan approval will be required after the severance and zoning have been approved. This process will evaluate the proposed expansion, site engineering and other matters.

REQUIRED STUDIES AND REPORTS

Stage 1 Archeological Assessment

As required by Niagara Region, a Stage 1 Archeological Assessment was prepared for the subject lands by Detritus Consulting in 2024.

Based on the assessment of the property contained within the Stage 1 Report provided with the applications, the consultant has advised that the subject lands exhibit a moderate to high potential for the discovery of archaeological resources. Accordingly, a Stage 2 Assessment has been recommended.

The Stage 2 Assessment was completed in May of 2024. No archeological resources were encountered through the Stage 2 Assessment. The report has been forwarded to the Ministry of Tourism, Culture and Sport for review and inclusion in the Ontario Public Register of Archeological Reports.

Stormwater Management Plan

A Stormwater Management Study has been prepared by Upper Canada Consultants that provides an overview of the existing and proposed stormwater management methods utilized on the subject lands

As outlined in the report, stormwater collected on 5377 Elcho Road is currently directed to roadside ditches along Elcho Road or Wellandport Road over grade or by swale. These flows then proceed under Wellandport Road westward towards Parker's Creek.

The portion of 5357 Elcho Road to be added to 5377 Elcho Road is used for agricultural purposes and also conveys stormwater flows to Wellandport Road.

The proposed stormwater management method for this merged property will be to continue to convey stormwater drainage overland. The flows will be captured through perimeter swales and directed to the proposed stormwater management wet pond facility. The pond will provide quality and quantity controls prior to outletting to the roadside ditch.

PROVINCIAL PLANS

Development applications within this area of the Township of West Lincoln are subject to the Ontario Planning Act (R.S.O. 1990), 2020 Provincial Policy Statement and the 2020 Growth Plan for the Greater Golden Horseshoe. An assessment of how the applications satisfy applicable Provincial legislation and policies is provided below.

PLANNING ACT (R.S.O. 1990)

The Planning Act regulates land use planning in the Province of Ontario. The Act prescribes matters of Provincial Interest concerning land use planning and the necessary procedures to be followed when making applications for development.

Section 2 of the Planning Act outlines matters of Provincial interest that the Planning Authority must have regard for when considering applications for development. These matters of Provincial interest include:

- a) the protection of ecological systems, including natural areas, features and functions;*
- b) the protection of the agricultural resources of the Province;*
- c) the conservation and management of natural resources and the mineral resource base;*
- d) the conservation of features of significant architectural, cultural, historical, archaeological or scientific interest;*
- e) the supply, efficient use and conservation of energy and water;*
- f) the adequate provision and efficient use of communication, transportation, sewage and water services and waste management systems;*
- g) the minimization of waste;*
- h) the orderly development of safe and healthy communities;*
 - (h.1) the accessibility for persons with disabilities to all facilities, services and matters to which this Act applies;*
- i) the adequate provision and distribution of educational, health, social, cultural and recreational facilities;*
- j) the adequate provision of a full range of housing, including affordable housing;*
- k) the adequate provision of employment opportunities;*
- l) the protection of the financial and economic well-being of the Province and its municipalities;*
- m) the co-ordination of planning activities of public bodies;*
- n) the resolution of planning conflicts involving public and private interests;*

- o) the protection of public health and safety;*
- p) the appropriate location of growth and development;*
- q) the promotion of development that is designed to be sustainable, to support public transit and to be oriented to pedestrians;*
- r) the promotion of built form that,*
 - (i) is well-designed,*
 - (ii) encourages a sense of place, and*
 - (iii) provides for public spaces that are of high quality, safe, accessible, attractive and vibrant;*
- s) the mitigation of greenhouse gas emissions and adaptation to a changing climate. 1994, c. 23, s. 5; 1996, c. 4, s. 2; 2001, c. 32, s. 31 (1); 2006, c. 23, s. 3; 2011, c. 6, Sched. 2, s. 1; 2015, c. 26, s. 12; 2017, c. 10, Sched. 4, s. 11 (1); 2017, c. 23, Sched. 5, s. 80.*

The applications have regard for clauses a), b), d), k) and p) of Section 2 of the Planning Act.

- a) the protection of ecological systems, including natural areas, features and functions;*

The proposed expansion area is contiguous to 5377 Elcho Road, on the north side. The northern property limit (i.e. development) will be located greater than 120 metres from mapped natural heritage features on the northern end of 5357 Elcho Road. This distance serves as a general screening area under provincial policies, and as development is proposed outside of this distance, the need for natural heritage assessment has been waived.

There are no anticipated impacts to these features that would be generated by these applications. The use of lands adjacent to the features will continue to be agricultural, which is permitted.

- b) the protection of the agricultural resources of the Province;*

The existing use of 5377 Elcho Road is an agriculture-related commercial use. Agriculture-related uses are permitted in Prime Agricultural Areas as they support farm operations and agriculture, and therefore contribute to the protection of the Province's agricultural resources.

The expansion of the existing agriculture-related commercial operations is desirable and will ensure the long-term sustainability of the business and will ensure that necessary

agricultural products are available close to market for agricultural producers and the rural community.

- d) the conservation of features of significant architectural, cultural, historical, archaeological or scientific interest;

Stage 1-2 Archeological Assessments have been completed on the subject lands. The lands were not found to contain any archeological resources.

- k) the adequate provision of employment opportunities;

The existing commercial operation at 5377 Elcho Road currently provides local employment opportunities and supports local rural businesses such as farmers, servicing contractors and equipment operators. The expansion of this existing use is necessary to support long term economic resiliency, which in turn will result in stable and/or new employment opportunities in the community.

- p) the appropriate location of growth and development;

The location of the proposed expansion is considered the most appropriate area. Expansion northward will retain existing separation between the commercial use and residential dwelling to the east. Furthermore, the expansion will not encroach within any areas of influence associated with natural heritage features to the north.

This small expansion is preferable to a relocation of the existing business, which benefits from its current location amongst other rural lands uses and in close proximity to regional roadways.

Section 34 – Zoning By-laws and Amendments

Applications for Zoning By-law Amendments are considered under Section 34 of the Planning Act. Amendments are permitted to municipal by-laws subject to the provision of prescribed information. This application has been filed with the required fee and supporting materials requested through pre-consultation.

Section 53 – Consents

Applications for Consent are governed under Section 53 of the Planning Act. Section 53(12) states that an Approval Authority when considering an application for Consent, must have regard for the matters under Section 51(24) which apply to Plans of Subdivision. An evaluation of how the proposed consents satisfy this criteria is provided below:

- a) the effect of development of the proposed subdivision on matters of provincial interest as referred to in section 2;

As noted above, the applications satisfy Section 2, clauses a), b), d), k) and p) of Section 2 of the Planning Act.

- b) whether the proposed subdivision is premature or in the public interest;

The proposed consent application will be advanced after the consideration and approval of the extension of Commercial Zoning onto Part 2. The related Zoning By-law Amendment is required to establish minimum lot area for the retained parcel (Part 3).

- c) whether the plan conforms to the official plan and adjacent plans of subdivision, if any;

The application conforms to the Township of West Lincoln Official Plan.

A detailed overview of specific conformity with relevant policies of Official Plan policies is provided further on in this report.

- d) the suitability of the land for the purposes for which it is to be subdivided;

Part 2 is suitable for severance as it is contiguous to the existing commercial operation.

- (d.1) if any affordable housing units are being proposed, the suitability of the proposed units for affordable housing;

Residential development is not proposed. This provision is not applicable.

- e) the number, width, location and proposed grades and elevations of highways, and the adequacy of them, and the highways linking the highways in the proposed subdivision with the established highway system in the vicinity and the adequacy of them;

5357 Elcho Road has existing access provided from Elcho Road, which is a Township owned and maintained road.

*5377 Elcho Road has existing access from Wellandport Road (Regional Road 27) and Elcho Road. An additional access to Elcho Road is proposed from the expansion parcel (Part 2), as shown on the preliminary grading plan included as **Appendix V** to this report.*

- f) the dimensions and shapes of the proposed lots;

The proposed expansion area (Part 2) measures 2.03 hectares in area. This Part has 102.61 metres of frontage along Wellandport Road and 289.14 metres of lot depth along the northern limit.

Once merged, Part 1 and 2 will cumulative measure 4.05 hectares and will have 128.93 metres of frontage on Elcho Road, 251.57 metres of flankage along Wellandport Road. The eastern lot line depth will increase to 193.67 metres.

- g) the restrictions or proposed restrictions, if any, on the land proposed to be subdivided or the buildings and structures proposed to be erected on it and the restrictions, if any, on adjoining land;

There are no restrictions to development on the portion of 5357 Elcho Road to be added to 5377 Elcho Road.

- h) the adequacy of utilities and municipal services;

The subject lands are currently supported by private services.

Both parcels will remain unaffected by the applications, and no new physical development is proposed, except for a required stormwater management facility.

- i) the adequacy of school sites;

The proposed severance will have no impact on local school enrollments.

- j) the area of land, if any, within the proposed subdivision that, exclusive of highways, is to be conveyed or dedicated for public purposes;

There are no lands, exclusive of highways, to be conveyed for public purposes. The provision of cash-in-lieu of parkland will be required as a condition of severance.

- k) the extent to which the plan's design optimizes the available supply, means of supplying, efficient use and conservation of energy; and

No physical development is proposed that would require energy inputs.

- l) the interrelationship between the design of the proposed plan of subdivision and site plan control matters relating to any development on the land, if the land is also located within a site plan control area designated under subsection 41 (2) of this Act or subsection 114 (2) of the *City of Toronto Act, 2006*. 1994, c. 23, s. 30; 2001, c. 32, s. 31 (2); 2006, c. 23, s. 22 (3, 4); 2016, c. 25, Sched. 4, s. 8 (2).

If the zoning and consent applications are approved, the commercial expansion will be subject to a Site Plan approval process.

2020 PROVINCIAL POLICY STATEMENT

Managing and Directing Land Use to Achieve Efficient and Resilient Development and Land Use Patterns (PPS 1.1)

The subject lands are located within the Prime Agricultural Area, north of the Wellandport Settlement Area Boundary within the Township of West Lincoln.

Prime Agricultural Areas are defined by the PPS as:

“...areas where prime agricultural lands predominate. This includes areas of prime agricultural lands and associated Canada Land Inventory Class 4 through 7 lands, and additional areas where there is a local concentration of farms which exhibit characteristics of ongoing agriculture. Prime agricultural areas may be identified by the Ontario Ministry of Agriculture and Food using guidelines developed by the Province as amended from time to time. A prime agricultural area may also be identified through an alternative agricultural land evaluation system approved by the Province.”

The subject lands are located within the Provincially defined “Rural Area”. The PPS denotes that Rural Areas are those lands that may include rural settlement area, rural lands, prime agricultural areas, natural heritage features and areas, and other resource areas. These areas are to be leveraged for their unique character and ability to contribute to a strong rural economy.

As set out in Policy 1.1.4.1 of the PPS, strong rural areas can be achieved by promoting the diversification of the economic base through the permission of on-farm diversification or value-added uses and employment opportunities in the prime agricultural area. However, when developing such uses, the PPS notes that it is important to have regard for scale, impacts on the agricultural community including adjacent uses and servicing.

The Zoning By-law Amendment will expand existing Service Commercial zoning onto a 2.03 hectare portion of 5357 Elcho Road to facilitate the physical expansion of established agriculture-related uses operating from 5377 Elcho Road. The continued operation and expansion of these business will have a positive economic benefit on the agricultural community and support the long-term preservation of agriculture in the surrounding area.

Infrastructure and Public Service Facilities (PPS 1.6)

Section 1.6 of the PPS pertains to servicing (water, sanitary), stormwater management, transportation and infrastructure corridors and waste management. As the subject lands are located outside of a Settlement Area, the policies pertaining to private services and stormwater management are applicable. The subject lands do not contain and are not adjacent to major transportation systems or infrastructure corridors.

Sewage, Water and Stormwater (Section 1.6.6.)

Overall, municipal servicing methods are required and preferred to support development, however, the PPS acknowledged that there are some circumstances where such services are not available or appropriate to provide. Policy 1.6.6.1 e) of the PPS outlines the preferred hierarchy of servicing and permits the consideration of the use of private servicing options set out in Policies 1.6.6.3, 1.6.6.4 and 1.6.6.5. Policy 1.6.6.4 of the PPS is relevant to these applications as there are no available municipal services in place or available to connect to in this area.

Policy 1.6.6.4 states that *“Where municipal sewage services and municipal water services or private communal sewage services and private communal water services are not available, planned or feasible, individual on-site sewage services and individual on-site water services may be used provided that site conditions are suitable for the long-term provision of such services with no negative impacts. In settlement areas, individual on-site sewage services and individual on-site water services may be used for infilling and minor rounding out of existing development.”*

The existing dwelling at 5357 Elcho Road is currently supported by a cistern and septic system. The existing businesses at 5377 Elcho Road are also supported by cistern and septic. These existing servicing methods are permitted and therefore consistent with the directions of the PPS. As no new buildings are being proposed as a result of these applications, there will be no further burden on the septic or potable water supplies.

Policy direction pertaining to Stormwater Management best practices is provided in Policy 1.6.6.7 of the PPS. Currently, on-site stormwater is conveyed through swales and grading to roadside ditches. The expansion of the agriculture-related commercial uses will add additional land area and flat surface to 5377 Elcho Road, which will generate greater stormwater flows than the current agriculture use. As outlined in the Stormwater Management Report prepared by Upper Canada Consultants, stormwater will require both quality and quantity controls.

The proposed stormwater management method outlined in the report is consistent with the PPS as it will protect human health, property and the environment and provide appropriate treatment before being released into the natural environment.

Long-Term Economic Prosperity (PPS 1.7)

Section 1.7 outlines various manners in which economic prosperity should be supported in Ontario communities. Policy 1.7.1 i) denotes that *“sustaining and enhancing the viability of the agricultural system through protecting agricultural resources, minimizing land use conflicts, providing opportunities to support local food, and maintaining and improving the agrifood network”* is desirable.

The Zoning By-law Amendment will expand existing Service Commercial (C3) zoning onto a 2.03 hectare portion of 5357 Elcho Road to facilitate the physical expansion of established agriculture-related commercial uses operating from 5377 Elcho Road.

The continued operation and expansion of these business will have a positive economic benefit on the agricultural community and support the long-term preservation of agriculture in the surrounding area, consistent with the directions on the PPS.

Natural Heritage (PPS 2.1)

As outlined in Section 2.1 of the PPS, natural features and areas are to be protected for the long term. These features include significant wetlands, significant woodlands, significant valleylands, significant wildlife habitat, significant areas of natural and scientific interest and coastal wetlands. This protective policy framework is also applicable to natural heritage features on adjacent lands.

Through preliminary review by Niagara Region and the NPCA, the site has been confirmed to contain and be adjacent to natural heritage features as defined in Section 2.1 of the PPS that include a Provincially Significant Wetland and Significant Woodland.

Per Policy 2.1.5 of the PPS, development and site alternation shall not be permitted in significant wetlands or significant woodlands in Ecoregions 6E and 7E, which includes Niagara, unless it has been demonstrated that there will be no negative impacts on the features or their natural functions. Similarly, Policy 2.1.8 of the PPS restricts development on adjacent lands to the features unless it can be similarly demonstrated that there will be no negative impacts to the features.

The proposed lot creation boundary and limit of Commercial (C3) Zoning will be located greater than 120 metres from the noted features. Given this separation distance, the review agencies have waived the requirement for an Environmental Impact Study to be submitted with the applications.

As the proposed development will occur greater than 120 metres from identified natural heritage features, there are no significant negative impacts that would be generated by the proposed expansion. Therefore, the applications are considered to be consistent with the policies of Section 2.1 of the PPS.

Agriculture (PPS 2.3)

The subject lands are within the Rural Area, as defined by the PPS. More specifically, the subject lands are within a Prime Agricultural Area.

Policy 2.3.1 of the PPS directs that Prime Agricultural Areas are to be protected for the long-term use for agriculture. The subject lands are currently vacant and are used for seasonal cash crop production (i.e. soy, winter wheat). The lands not being conveyed through the severance (i.e. Part 3) will continue to be used for agricultural purposes.

Policy 2.3.4.1 pertains to lot creation in prime agricultural areas. More specifically, policy 2.3.4.1. b) states that “Lot creation in Prime Agricultural Area is discouraged and may only be permitted for agricultural-related uses, provided that any new lot will be limited to a minimum size needed to accommodate the use and appropriate sewage and water services.

The proposed size of Part 2 is 2.03 hectares, which has been identified as the minimum area required to facilitate the needs of the existing business. This expansion area will not include any structures and will have a negligible impact on existing water and septic systems. A small portion of Part 2 will be utilized for a new stormwater management facility to ensure there are no negative stormwater impacts generated by the increase in impervious area.

Cultural Heritage and Archaeology (PPS 2.3)

Policy 2.6.2 of the PPS states that *“development and site alteration shall not be permitted on lands containing archaeological resources or areas of archaeological potential unless significant archaeological resources are conserved”*.

Through pre-consultation in 2023 the subject lands were identified as exhibiting archaeological potential by Niagara Region. Accordingly, Niagara Region has requested the completion and

submission of a Stage 1 Archaeological Assessment, at minimum, with the Zoning By-law Amendment application.

The applicant retained Detritus Consulting Ltd. to prepare the required Stage 1 Archaeological Assessment of the property. This report was prepared in 2024 and confirms that the subject lands exhibit archaeological potential.

Accordingly a Stage 2 assessment was completed in May of 2024. No archeological resources were encountered during the Stage 2 Assessment.

The Stage 1 and 2 Reports have been filed with the Ministry of Tourism, Culture and Sport for review and acceptance into the public registrar. A letter of concurrence has not yet been issued.

PROVINCIAL GUIDELINES FOR PERMITTED USES IN ONTARIO'S PRIME AGRICULTURAL AREAS

As noted previously in this report, some of the existing commercial uses operating at 5377 Elcho Road in West Lincoln are considered agriculture-related uses due to their direction relationship with the rural and agricultural community. It is these uses that require the land expansion.

Per Policy 2.3.3.1 of the PPS, agriculture-related uses are permitted in Prime Agricultural Areas and are to be compatible with and not hinder surrounding agricultural operations.

Criteria for their establishment is inferred to be provided in Provincial Guidelines which, in this case, is the document entitled "Guidelines on Permitted Uses in Ontario's Prime Agricultural Areas (Publication 851).

Section 2.2 of the Guidelines pertains to agriculture-related uses and outlines six (6) criteria to be considered and met when proposing agriculture-related uses in the Prime Agricultural Area. An overview of conformity with these guidelines is provided in the following section.

1. Farm-related commercial and farm-related industrial use.

The Guidelines indicate that farm-related commercial uses include retailing of agriculture-related products, livestock assembly yards and farm equipment repair shops.

The existing commercial operation contains two companies that sell agricultural field materials (tiles, piping) and repairs and rents agricultural equipment. These services are integral to the farm community.

2. Shall be compatible with, and shall not hinder, surrounding agricultural operations.

Immediate adjacent agricultural operations only include the lands to be rezoned (5357 Elcho Road) which bounds the site to the north and east. Other adjacent agricultural operations are located on the west side of Wellandport Road (Regional Road 27) but are limited in scale. The predominant adjacent land uses to the subject properties are rural residential.

The willingness of the adjacent landowner to provide additional lands to the existing commercial uses demonstrates that they have no concern about the expansion hindering their active agricultural operation.

3. Directly related to farm operations in the area.

The products and services of the subject agriculture-related use are integral to any farming community, and are therefore integral to the immediately surrounding farming operations.

4. Supports agriculture.

The supply of agricultural drainage and liquid storage materials, and the repair and rental of agricultural equipment are vital services for agricultural operators.

5. Provides direct products and/or services to farm operations as a primary activity.

Both Ontario Agra Piping and Kor Rentals provide materials and equipment to the agricultural community as a primary activity.

6. Benefits from being in close proximity to farm operation.

The proposed expansion is logically proposed next to the existing uses. The subject lands are located central to the surrounding agricultural community in West Lincoln, Wainfleet, Pelham, Lincoln and Haldimand County. This proximity allows for convenient access for farmers and limited travel for delivery of equipment and materials without the need for accessing large highways.

Enercon, which is an energy related group, also utilizes a portion of the existing site for the parking of work vehicles and has a small office space. Enercon provides technical repair and support services for the wind energy projects in west Niagara that exist on agricultural properties. Ensuring their continued availability to operate on site supports these energy projects which are typically utilized by the agricultural community to supplement revenue and due to setback and locational restrictions.

Based on the analysis provided, the applications and development proposal are considered to meet the requirements for agriculture-related uses set forth in the Provincial Guidelines.

2020 GROWTH PLAN FOR THE GREATER GOLDEN HORSESHOE

Rural Areas (PTG 2.2.9)

Rural Areas are not defined or identified within the Growth Plan, but can be interpreted using the definition found in the Provincial Policy Statement (2020) which includes rural settlement areas, rural lands, prime agricultural areas, natural heritage features and areas, and resource areas.

Section 2.2.9.3 of the Growth Plan states that development outside of settlement areas may be permitted on rural lands for a variety of cultural and economic opportunities, the management of resources, resource based recreational uses, or other rural uses that are not appropriate in settlement areas, subject to criteria pertaining to compatibility, serviceability and impacts on the agricultural community.

The submitted applications will facilitate the expansion of existing agriculture-related commercial land uses that directly service the surrounding rural and agricultural community. Although the existing uses could be considered appropriate and compatible to locate within a settlement area, the current location is long-established, conveniently accessible for the intended and existing client base and is adequately separated from sensitive uses that may be impacted by dust or noise associated with day to day operations.

The applications will facilitate a development expansion that is compatible with the rural landscape, and surrounding land uses, can be sustained by existing rural services and will not adversely affect the protection of agricultural uses.

Natural Heritage System (PTG 4.2.2)

Lands outside of a Settlement Areas may be subject to the provincial natural heritage system policies if they contain key natural features or key hydrologic features.

Per Policy 4.2.2.3 of the Growth Plan, applications for development and/or site alteration must demonstrate there will be no negative impacts to key natural heritage features or key hydrologic features, that connectivity between features is maintained, and that there will be no unnecessary removal of features. In cases where vegetation or feature removal must occur, 30 percent of the total developable area of a property must remain vegetated or be returned to a state of natural self-sustaining vegetation.

The property known as 5357 Elcho Road contains natural heritage features at the northern end of the property which include a provincially significant wetland, significant woodland, watercourse and environmental corridor. These features are located approximately 190 metres

from the northern limit of Part 2, which is the environmental impact study threshold for impacts per policy 4.2.4.1 of the Growth Plan.

The expansion of the C3 Zoning onto Part 2 is not expected to result in any negative impacts on the noted key natural heritage and key hydrologic features due to the physical separation distance and that existing agricultural cultivation activities will continue to occur within the intermediary lands on Part 3.

Agricultural System (PTG 4.2.6)

As directed by the Growth Plan, the Province has identified the Agricultural System for the Greater Golden Horseshoe. Such agricultural lands are to be designated in accordance with Provincial mapping and protected for the long-term for agricultural purposes.

The applications conform with the overall policy direction of the Growth Plan by proposing the development of a small portion of agricultural land to support the expansion of agriculture-related commercial uses. Such uses are permitted and encouraged by the Province as a means to support the long-term viability of agriculture in Ontario communities.

Cultural Heritage Resources (PTG 4.2.7)

Policy 4.2.7.1 of the Growth Plan encourages municipalities to prepare Archaeological Master Plans as tools to use in the consideration of development applications.

In the absence of a Township archaeological master plan, the Regional Municipality of Niagara is the Planning authority with delegated responsibility for identifying archaeological potential and requesting studies in accordance with the Ontario Ministry of Citizenship and Multiculturalism protocols.

As requested by Niagara Region, a Stage 1 Archeological Assessment was completed by Detritus Consulting Ltd. in 2024. This report concludes that the subject lands exhibit archaeological potential and will require a Stage 2 assessment inclusive of test pitting. Subsequently, a Stage 2 Assessment of the subject lands was completed, which did not result in the identification of archeological resources.

The Stage 1 and Stage 2 Reports have been submitted to the Ministry of Tourism, Culture and Sport for review and acceptance into the Provincial registrar of archeological reports.

NIAGARA OFFICIAL PLAN (2022)

The Niagara Official Plan (2022) outlines the long-term strategic policy planning framework for managing growth in the Region to a planning horizon ending in 2051. This plan was approved by the Minister of Municipal Affairs and Housing on November 4, 2022.



Figure 10 - Schedule F of the Niagara Official Plan (2022)

The location of the subject lands is identified in **Figure 10**, which shows both 5357 and 5377 Elcho Road as being designated as Prime Agricultural Area on Schedule F – Agricultural Land Base of the Niagara Official Plan.

Applicable agricultural policies are contained within Chapter 4 of the NOP, entitled “Competitive Region”.

Chapter 4 – Competitive Region

4.1.1 Region’s Agricultural Land Base

Policy 4.1.1.2 of the NOP requires that prime agricultural areas, as shown on Schedule F, shall be protected for the long term use of agriculture.

The remnant portions of Part 3 will continue to be actively cultivated, thus upholding the long term use of the property for agriculture uses as encouraged in the NOP.

The lands to be added to 5377 Elcho Road will be utilized for an expansion of an existing commercially based agricultural-related use. Such uses are desirable, as they support the farming community and rural communities.

4.1.2 Specialty Crop Areas and Prime Agricultural Areas

Section 4.1.2 of the NOP contains the land use policies which apply to Prime Agricultural Areas within Niagara.

Policy 4.1.2.3 requires that “In specialty crop areas and prime agricultural areas, all types, sizes and intensities of agricultural uses and normal farm practices shall be promoted and protected and a full range of agricultural uses, agriculture-related uses and on-farm diversified uses are permitted.”

As outlined previously in this report, the existing commercial operations are agriculture-related and support the surrounding rural community. Accordingly, the expansion of this use should be promoted to achieve greater agricultural goals.

4.1.3 Minimize Conflicts of Non-Agricultural Uses

Non-agricultural uses within the agricultural areas have the potential to generate adverse or significant impacts on the agricultural community depending on their nature. In some cases, non-agricultural uses may be appropriate based on need or condition. Many non-agricultural land uses within the agricultural area are long standing.

Policy 4.1.3.1 requires that “Non-agricultural uses should not be located in specialty crop areas or prime agricultural areas.” The applications do not offend this policy as the existing commercial use can be considered as an agriculturally-related use. It is not a “non-agricultural use” due to its direct relationship with the agricultural community. Accordingly, the balance of the policies of Section 4.1.3 should not apply.

4.1.4 Lot Creation and Related Development within the Agricultural System

Similar to the policy direction of the 2020 PPS, lot creation is discouraged in Prime Agricultural Area.

In such scenarios where lot creation is proposed for non-residential purposes, development must be supported by sustainable on-site private water and sanitary services.

The existing development at 5377 Elcho Road is supported by private sewage (septic bed) and water services. The proposed boundary adjustment does not include new development and therefore does not increase demand for the existing services.

The existing dwelling that is located on the remnant lands (5357 Elcho Road) is also serviced with private sewage and water systems. These systems will not be impacted by the proposed boundary adjustment.

4.1.6 Lot Creation in Prime Agricultural Areas

The lot creation policy framework of the NOP is clear and contains a set of specific requirements that must be satisfied. These tests are divided into three application streams being 1) agricultural lot creation, 2) agriculturally related lot creation, 3) residential surplus dwelling severances and 4) legal or technical severances.

As the application is seeking to sever and add additional land to facilitate the expansion of an agriculturally-related use, Policy 4.1.6.1 b. (agriculturally-related lot creation) apply. These requirements are evaluated below:

- i. any new lot shall be limited to a minimum size needed to accommodate the proposed use and appropriate sewage and water services; and*

As noted, the subject lands contain several agriculture-related businesses on one property. This enables the lands to be used more efficiently than if each business was on a separate property as only one parking area, septic system and stormwater management pond are currently required to support all of the businesses.

The businesses have outgrown the current property and wish to expand onto the adjacent lands. Part 2 on the severance sketch represents the required amount of land needed by the owners of 5377 Elcho Road to facilitate the expansion of the existing businesses.

The expansion of the existing agriculture-related businesses onto the adjacent lands is desirable as it maintains the existing land use efficiencies and therefore limits the amount of agriculture lands being developed than if an entirely new property was required to be established to enable the expansion.

The proposed land area to be added is 2.03 hectare or approximately 5 acres. The lands will be primarily used for the temporary outdoor storage of agricultural materials received from manufacturers prior to being taken to site for installation.

The existing private water and sanitary systems are considered to remain adequate for the commercial use as no new buildings or water consuming fixtures are being proposed. The small decrease in the lot area of 5357 Elcho Road will not result in any impacts on their existing septic system.

- ii. *any new lot shall be zoned to preclude residential uses in perpetuity.*

The subject lands do not currently contain any existing residential uses.

The concurrent Zoning By-law amendment will Zone Part 2 as Service Commercial (C3), which is the same zoning in place on 5377 Elcho Road. The C3 Zone does not permit new residential land uses to be developed. Accordingly, the proposed zoning category will ensure that no new residential land uses occur on the property, in conformity with Policy 4.1.6.1 b..

4.1.7 A Resilient Agricultural Economy

Policy 4.1.7.3 of the NOP permits agricultural uses, agriculture-related uses and on-farm diversified uses within prime agricultural areas. Table 4-1 of the NOP outlines these types of uses in greater detail, as shown in **Figure 11** below:

Type of Use	Agricultural Uses	Agriculture-Related Uses	On-Farm Diversified Uses
Description	Growing of crops or raising of livestock; raising of other animals for food, fur or fibre; aquaculture; apiaries; agro-forestry; maple syrup production; and associated on-farm buildings and structures	May or may not be on a farm; farm-related commercial or industrial use; compatible with surrounding agricultural operations; directly related to farms in the area; supports agriculture, provides products or services to farms; benefits from proximity to farms	On a farm; secondary use; limited in area; includes, but is not limited to, home occupations, home industries, <i>agri-tourism uses</i> and value-added uses; compatible with surrounding agricultural operations
Examples include, but are not limited to	a. cropland b. pastureland c. barns and other associated buildings and structures	a. processing of agricultural products b. farm equipment repair shop c. agriculture research centre	a. <i>agri-tourism uses</i> b. pick-your-own operation c. home occupations

Figure 11 - Table 4-1 of the Niagara Official Plan

As demonstrated previously, the existing uses occurring at 5377 Elcho Road are agriculture-related uses that align with the examples contains in Table 4-1.

Section 4.1.7.8 provides the criteria that are to be considered when reviewing applications for proposed agriculture-related uses. The noted criteria are applicable to the establishment of new agriculture-related use. As the applications will facilitate the expansion of existing agriculture-related uses, it is still deemed appropriate to consider how the expansion conforms with these polices.

- a. whether the proposed activity is more appropriately located in a nearby settlement area or on rural lands;

The applications apply to the expansion of an existing legally-established agriculture-related use. The proposed expansion is logical and contiguous with the existing area that has been established for this use and the location is therefore considered to be appropriate.

- b. whether the use is required for or in close proximity to the agricultural operation for it to support and complement the agricultural activity;

As previously established, the proposed use is agriculture-related. Its location in proximity to farming operations is a benefit to the agricultural uses which it supports, as well as to the businesses themselves.

- c. the extent to which the use is compatible with the existing farming operation and surrounding farming operations;

The existing use does not interfere with surrounding farming operations. The proposed expansion is for storage, and similarly does not create impacts that would interfere with farming operations.

- d. whether the scale of the activity is appropriate to the site and farming operation;

The proposed expansion is intended to be used as temporary materials storage. This is a passive use and does not create negative impacts on surrounding farming operations. Equipment and materials storage are also common practices on agricultural farms.

- e. whether the use is consistent with and maintains the character of the agricultural area;

The proposed expansion represents the expansion of an existing legally established agriculture-related use and does not significantly alter the character of the area.

- f. the use does not generate potentially conflicting off-site impacts;

As noted, the proposed expansion is intended to be utilized for storage which is a passive use. No off-site impacts are anticipated.

- g. the activity does not include a new residential use;

No new development, including residential development is proposed. The lands subject to the boundary adjustment are proposed to be zoned as Service Commercial (C3) which does not permit residential development.

- h. the use is limited to low water and low effluent producing uses and the site is capable of accommodating the use on private water and private sewage treatment systems; i. the use does not require significant improvements to infrastructure; and

The existing agriculture-related businesses are supported by private water and sewage systems. The proposed expansion does not increase the demand for these services.

- i. the use complies with all other applicable provisions of this Plan.

Conformity to the other applicable policies in the NOP is evaluated in this report.

4.1.10 – Non-Conforming Uses in the Agricultural System

Section 4.1.10 of the NOP contains the policies related to the continuation and expansion of legally established, non-conforming uses in the Agricultural System. These policies are not applicable as the existing uses were legally established, and are agriculture-related uses, which are permitted within Prime Agricultural Areas.

Chapter 3 – Sustainable Region

Figure 12 has been generated by Niagara Region’s online natural heritage mapping viewer and shows mapped natural heritage features on, and adjacent to the subject lands. These features include provincially significant wetlands (hatched area), significant woodlands (green), watercourses (blue lines) and environmental corridors/linkages (purple).

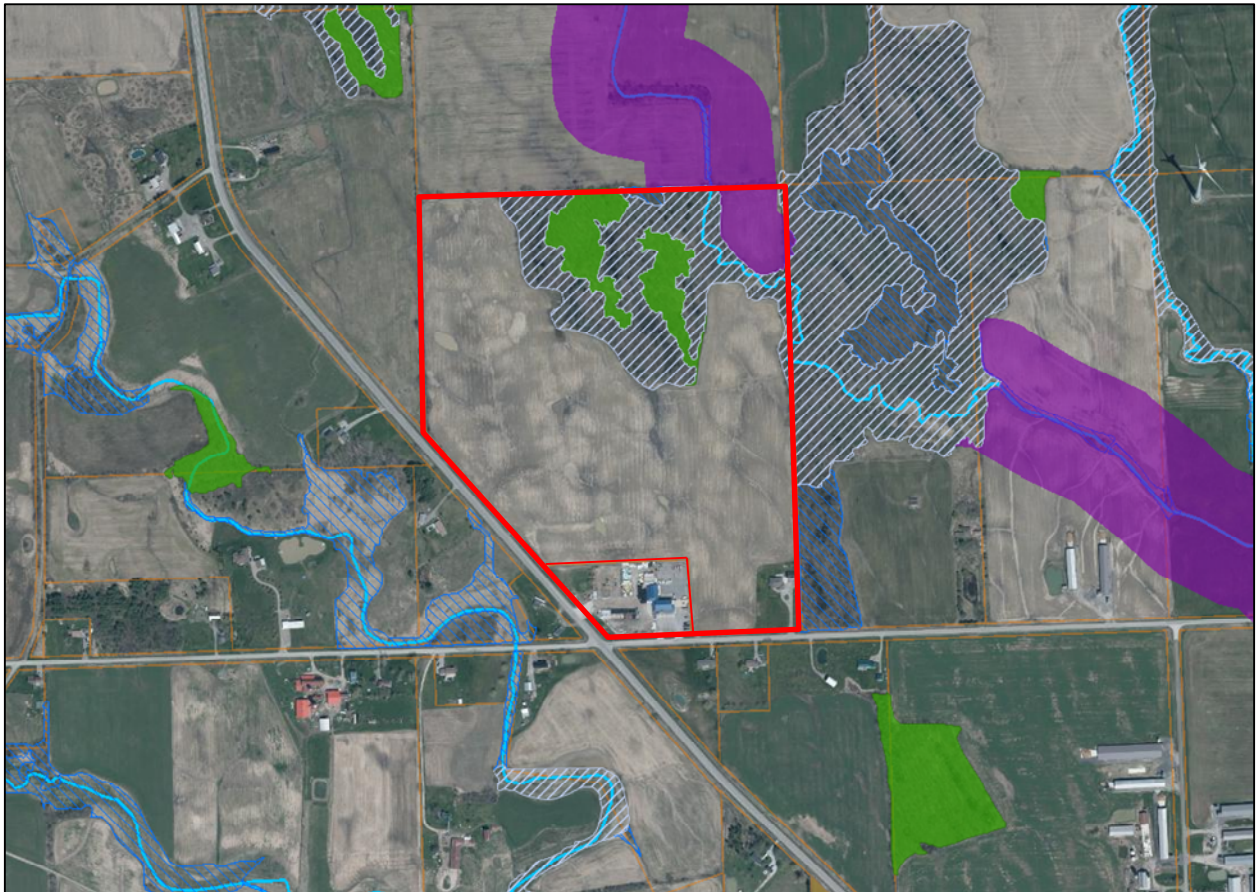

Figure 12 - Niagara Region Mapped Natural Heritage Features

Given the location of these features and their proposed separation distance between the expansion lands no assessment of natural heritage impacts through professional study was requested. Accordingly, the applications do not conflict with the Natural Heritage policies of the NOP.

TOWNSHIP OF WEST LINCOLN OFFICIAL PLAN

The subject lands are designated as Good General Agricultural and Natural Heritage System on Schedule B-1 – Land Use Gainsborough within the Township of West Lincoln Official Plan, as shown in **Figure 13**. The subject lands are located north of the Wellandport Settlement Area.

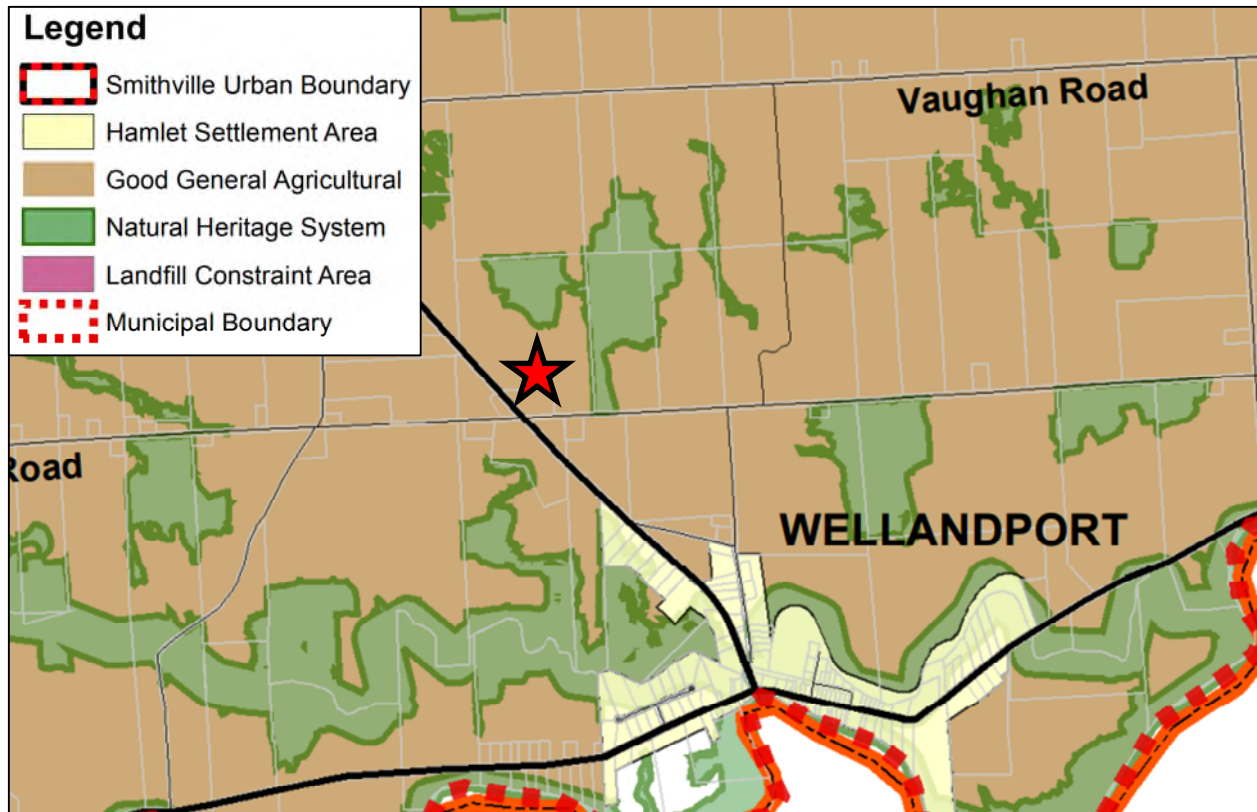

Figure 13 - Schedule A1 of Lincoln Official Plan (Cropped)

Section 4 – Agricultural Land Use Policies

As the subject lands are located within the Agricultural Area, the policies of Section 4 of the Official Plan are applicable. Per Policy 4.1, the agricultural area represents a mix of well diversified uses that will help to ensure the sustainability and viability of the Township’s agricultural industry. The applications pertain to agriculture-related uses provide materials and equipment which support agricultural uses. The applications are therefore consistent with the overall vision for the agricultural area as established in the Official Plan.

4.2 Objectives for all Agricultural Areas

Section 4.2 of the Township’s Official Plan outlines the general Objectives for Agricultural Areas. The proposal implements, or has regard for the following objectives:

- a) To promote and protect a viable agricultural industry for the production of crop resources and livestock operations to enhance employment opportunities and strengthen the economic wellbeing of West Lincoln.
- c) To promote small scale secondary uses and agriculture-related uses that are compatible with and do not hinder surrounding agricultural operations.
- e) To promote, where feasible, opportunities for agricultural related value added activities to support, promote, and develop the agricultural areas.

4.2.1 General Agricultural Policies

Section 4.2.1 contains the general policies that apply to all of the Township's Agricultural Policies. Within Section 4.2.1, policies a), c), d) and f) are relevant. These policies are evaluated in the following section.

Policy 4.2.1 a) outlines all permitted uses within all agricultural areas in West Lincoln, as well as general policies to guide the form and processes associated with development. These uses include:

- i. All types of Agricultural uses, new or otherwise, including, but not limited to, livestock operations, cash cropping, food production, forestry and natural heritage uses with a strong focus on specialty crop production.
- ii. Small scale agriculturally related uses related directly to, serving, and requiring close proximity to the surrounding agricultural areas may be permitted where no opportunities exist for such uses to be located with designated Urban and Hamlet Settlement Areas. The locating of these uses shall be subject to the policies of this plan.
- iii. Agricultural-related residential uses including help houses.
- iv. Uses secondary to the principal agricultural use of the property, including, but not limited to, home occupations, bed and breakfast establishments, home industries and uses that provide value-added agricultural products from the farm operation on the same property.
- v. Linear infrastructure facilities, and associated equipment, that are to serve the Township and Region including, but not limited, to: water supply and sewage treatment facilities, communication/telecommunication facilities and transportation networks. New infrastructure facilities will be of a size and nature to serve both the existing and future needs of Township residents and shall minimize the effects on surrounding farm operations. Proposals for new infrastructure facilities shall be in accordance with all provincial and regional requirements.
- vi. Passive open space and recreational uses such as trails in the Good General Agricultural Areas.

- ii. Approvals for servicing that are greater than 10,000 L/day will be issued by the Ministry of the Environment as per the requirements of the Ontario Water Resources Act.”

The applications conform with this policy as the existing dwelling at 5357 Elcho Road and commercial building at 5377 Elcho Road are both supported by private water and sanitary services (i.e. septic). The applications do not contemplate any new buildings or require increased servicing capacities and therefore the existing services are considered to be adequate and provided in conformity with the Official Plan.

Policy 4.2.1 f) requires that applications for consent within the Agricultural Areas shall be subject to the policies of Section 17.13 of the Official Plan. This Section is now numbered as Section 18.13 due to changes in the plan effected by Official Plan Amendment 147.

The severance application has been evaluated against the policies of Section 18.13 of the Official Plan further on in this report and is deemed to conform.

4.4 Good General Agriculture Areas

The subject lands are located within the Good General Agricultural Area and are subject to the policies and objectives of Section 4.4 of the West Lincoln Official Plan.

The Objectives for Good General Agricultural Areas are contained in section 4.4.1, and include:

- a) To encourage the preservation of Good General Agricultural Lands for agricultural purposes and to direct non-farm uses to Urban and Hamlet Areas.
- b) To provide the second highest level of protection to Good General Agricultural Lands next to the Unique Agricultural Lands, and are suitable for all types of field crops, livestock operations, and other agricultural uses.
- c) To promote the consolidation of larger agricultural holdings to strengthen the economic strength of the agricultural land base of the Township of West Lincoln.

The applications assist in the satisfaction of these objectives by preserving the balance of Part 3 for continued agricultural cultivation and utilization a small portion of the property that is contiguous to 5377 Elcho Road to support the expansion of established agriculture-related uses.

The Policies for Good General Agricultural Area are contained in Section 4.4.2 of the Official Plan. Each of the policies within this Section of the Official Plan are outlined and evaluated in the context of the applications below.

- a) Good General Agricultural Lands shall be given the second highest priority for preservation and protection as shown on Schedule ‘B-1’ – ‘B-3’ Land Use Maps.

This requirement is acknowledged. The subject lands are designated as Good General Agricultural lands on Schedule B1 of the Official Plan and will continue to be utilized for agricultural and agriculture-related use.

- b) Agricultural parcels shall be maintained at a sufficient size that is large enough to ensure the flexibility of that operation to adapt to economic conditions in agriculture in the future. Smaller agricultural parcels may be supported through the consent process, subject to the policies of Section 17.13: (Land Severances) provided that the resulting parcels are both for agricultural use and the size of the resulting agricultural parcels:
- i. Is appropriate for the agricultural activities proposed,
 - ii. Is suited to the particular location and common in the area, and
 - iii. Provides some flexibility for changes in the agricultural operation. The foregoing includes small lot severances for greenhouses and other intensive forms of agriculture subject to a condition that any new dwellings on the property are allowed only after the greenhouse or other farm buildings have been constructed or are substantially completed.

The remnant agricultural lands will be 30.65 hectares in area which is a sufficient size to support a viable farm operation.

- c) The consolidation of existing agricultural holdings into larger agricultural holding shall be generally supported. The consolidation of agricultural holdings through the consent process shall be subject to the policies of Section 17.13: (Land Severances) of this plan.

No farm consolidation is proposed as part of these applications.

- d) The location of greenhouses within the Good General Agricultural Area shall take into consideration the proximity of adjacent residential and non-farm uses. Specific standards for greenhouse operations shall be contained within the Township's Zoning By-law.

No greenhouses are proposed through these applications.

- e) Small Scale Commercial and Industrial Uses which do not require close proximity to agricultural operations shall be located in appropriately designated commercial or industrial areas within designated Settlement Areas. Small Scale Commercial and

Industrial Uses that are required to support the agricultural community shall be located so that they minimize the impact on the viability of existing and future agricultural operations. These uses shall be carefully regulated through a Zoning By-law Amendment as to their location, size and traffic generation in order to minimize potential disturbances and to ensure that private sewage disposal systems can accommodate the increase sewage loading to the satisfaction of the Township of West Lincoln.

The existing agriculture-related commercial uses are permitted uses within the C3 Zone. These operating agriculture-related commercial uses are considered to be in closer conformity with the intent and purpose of the official plan than other permitted uses and have benefitted greatly from their location within the agricultural area over the long term.

The proposed size of the expansion lands (Part 2) is considered adequate and appropriate given the needs of the existing operations and scale of materials stored on site. No new buildings are required to be developed as part of the applications. Subsequently there will be no impact on the existing septic and water systems on the subject lands.

Provisionally, an additional entrance is proposed to Wellandport Road however no study of this access was requested by Niagara Region. At this time there are no significant traffic impacts expected.

- f) New or expanding agricultural, small scale commercial or industrial, or agricultural value-added ancillary uses located within the Area of Possible Influence as defined in Section 16 shall be subject the policies of Section 16: (Waste Management) policies of this plan.

The subject lands are not located within the “Landfill Area of Possible Influence” cited in Section 16 of the Township of West Lincoln Official Plan.

- g) Within the Agricultural Designation there exist a number of legally established non-agricultural related uses, building and structures that have been recognized through the Township’s Zoning By-law. These uses can continue to exist as legally established, any changes to these uses, buildings and structures shall be in accordance with the applicable policies of the Township’s Official Plan and may require further approval through zoning by-law amendments, site plan approval, or other planning approvals as required.

The uses to be expanded are agriculture-related commercial uses, which are permitted under the Official Plan.

4.6 Agriculture-Related Uses and On-farm Diversified Uses

As noted throughout this report, the existing use of 5377 Elcho Road is agriculture-related. While no new agriculture-related commercial uses are contemplated, the physical expansion of these uses onto agriculture lands warrants an evaluation of the policies within Section 4.6 of the Official Plan to confirm the appropriateness of the expansion.

Agriculture-related uses and On-farm diversified uses may be permitted in accordance with the policies in this Plan and specifically in accordance with the following:

- a) The location of the facility or use imposes no operating constraints and results in no reduction of the efficiency of any existing farm.

The proposed expansion is contiguous to the existing agriculture-related use and is of a regular shape.

- b) An adequate and potable water supply is available.

The property has an existing private water supply. The proposed expansion does not significantly increase demand for this service.

- c) Soils are suitable or made suitable to support an individual waste disposal system subject to the approval of the authority having jurisdiction.

The commercial uses are supported by an existing private sewage (septic) system. As the proposed expansion is for storage, no significant additional demand on this system is anticipated.

- d) Adequate drainage and outlets are available for stormwater run-off. Approval of drainage provisions may be required from the appropriate agency.

A stormwater management pond is proposed to manage stormwater runoff. The future development will be subject to Site Plan approval through which the details of the stormwater management plan are reviewed.

- e) Adequate entrances and exits to roads are located to minimize travel hazards. Ribbon development along roadways is discouraged.

The proposed expansion does not result in the establishment of new entrances or exits.

- f) Adequate off-street loading, parking spaces and access points will be provided.

The required amount of parking spaces for the commercial uses is accommodated.

- g) Access points will be clearly defined by pavement breaks, landscaping, curbing or other acceptable means.

The proposed expansion does not alter the existing parking layout.

- h) Outside storage may be limited.

The requested zoning amendment seeks an increase in the amount of outdoor storage permitted on the site. The nature of the existing commercial uses requires significant outdoor storage area. The visual impact of outdoor storage can be mitigated through fencing or landscaping, as determined through the site plan approval process.

- i) The municipality may impose appropriate controls through available legislation to ensure that the hours of operation of a use do not conflict with adjacent land uses.

The commercial uses operate within normal business hours.

- j) The lands will be appropriately zoned and, where necessary, a development agreement will be required.

As required by this policy, a Zoning By-law Amendment has been applied for to zone the expansion area Service Commercial (C3), consistent with the existing zoning at 5377 Elcho Road. The expansion will also be subject to Site Plan control.

- k) Development on treed areas, steep slopes, ravines, watercourses and any other natural or cultural heritage resource will be avoided.

The expansion does not impact any natural areas described in this policy.

- l) Development may be subject to site plan control.

The policy further requires that Agriculture-related uses and on-farm diversified uses involving development over 500 square metres shall be subject to a zoning by-law amendment. Such amendments are to address the following matters:

- a) Whether the use is more appropriately located in a nearby settlement area;

The application pertains to the expansion of an existing agriculture-related use. Relocation of the use is not practical.

- b) Whether the use is required on or in close proximity to the agricultural operation to support and complement the agricultural activity;

The proposed use is agriculture-related. Its location in proximity to farming operations is a benefit to the agricultural uses which it supports, as well as to the businesses themselves.

- c) Whether the use is compatible with the existing farming operation and/or surrounding farming operations; and

The existing use does not interfere with surrounding farming operations. The proposed expansion is for storage, and similarly does not create impacts that would interfere with farming operations.

- d) Whether the use complies with all other applicable provisions of this Plan and the Regional Official Plan. Lot creation to accommodate agriculture-related or on-farm diversified uses is not permitted.

The proposed boundary adjustment is permitted under the Niagara Official Plan and conforms with the applicable policies of the Township's Official Plan as demonstrated in this report. The application does not propose the creation of a new lot, but rather the expansion of an existing lot. The application therefore does not conflict with this policy.

4.6.1. Agriculture-related uses

The Township's Official Plan requires that agriculture-related uses are small in scale, are directly related to, and required to be in close proximity to farm operations.

Section 8 – Heritage Conservation

As outlined in Section 8 of the Official Plan, Cultural Heritage resources include built heritage (i.e. heritage buildings), natural and human-made landscapes and archaeological resources.

The subject lands do not contain, and are not adjacent to any identified cultural heritage buildings or landscapes. However, the subject lands do exhibit archaeological potential and are required to be evaluated prior to the commencement of any development or site alteration.

Subsection 8.3.5 of the Official Plan pertains to archaeological resources. Specifically, policy 8.3.5. d) requires that:

“Development and site alteration shall only be permitted on lands containing archaeological resources or areas of archaeological potential if the significant archaeological resources have been conserved by removal and documentation, or by preservation in situ. Where significant archaeological resources must be preserved in situ (long-term in-ground protection of the

archaeological resource); only development and site alteration which maintain the heritage integrity of the site may be permitted.”

In conformity with this policy direction, a Stage 1 Archaeological assessment was completed for the subject lands by Detritus Consulting Ltd.

Section 10 – Natural Environment

Section 10 of the Township of West Lincoln Official plan pertains to the natural environment.

As outlined previously in this report, 5357 Elcho Road contains a Provincially Significant Wetland, Significant Woodland, Watercourse and Environmental Corridor at the northern end of the property.

The proposed northern boundary of the expansion is located approximately 190 metres from the closest point of these features, which is greater than the typical 120 metre screening area limit used to determine the need for environmental impact studies.

As the affected lands are located outside of this area of influence, and that the interceding agricultural use will continue on the balance of 5357 Elcho Road, there is no anticipated negative impact on natural heritage features on or adjacent to the subject lands. Accordingly, the applications are considered to conform with the policies of Section 10 of the Official Plan.

Section 14 – Infrastructure and Transportation

14.4 Stormwater Management

As required by Policy 14.4.1 a), the applications have been submitted with a stormwater management plan that has been prepared by Upper Canada Consultants.

The provided report outlined the current manner in which surface drainage occurs and proposes a stormwater management solution to capture, treat and control generated flows.

The provision of this plan satisfies the requirements of the Official Plan. Detailed comments on the functionality of the system will be provided for consideration during the review process.

14.5 Roads

Both properties related to this application have frontage and access provided from Elcho Road. The commercially zoned property (5377 Elcho Road) has an additional driveway access from Wellandport Road, being Regional Road 27. No additional or reconfigured accesses from Elcho Road are proposed to necessitated by these applications, however, the provisional site grading plan shows a new access to the expansion lands from Wellandport Road.

Per Section 14.5.2 of the West Lincoln Official Plan, considerations for access and design matters affecting Regional Roadways is not under the jurisdiction of the Township Plan. Niagara Region will be responsible for providing comments and requirements related to this proposed access.

Section 18 – Implementation

Section 18.13 (Formerly 17.13) of the Township Official Plan contains policies that are applicable to Consent applications within the township. Specifically, Section 18.13.1 contains general policies applicable to all Consent applications, and Section 18.13.2 pertains to severances in the Agricultural Area. Both policy subsets are outlined and evaluated below.

18.13.1 General Policies for Consents

- a) Development will be in accordance with the designated uses as shown on the Official Plan Land Use Maps and the provisions of the Zoning By-law.

The subject lands are designated as “Good General Agricultural” on Schedule B1 of the Official Plan.

The Good General Agricultural land use designation permits a range of agricultural and agriculture-related land uses. The expansion of the existing agriculture-related commercial uses is permitted by the Official Plan and is appropriately accommodated through the expansion of the Service Commercial Zone.

- b) Any lot or remnant parcel created must have adequate frontage on a public road that is maintained year-round and is of an adequate standard of construction to provide access for the intended use.

The remnant Parcel, being Part 3 (5357 Elcho Road) will retain x metres of frontage on Elcho Road and x metres along Wellandport Road (Regional Road 27)

- c) No land severance shall create a traffic hazard, or have limited sight lines on curves or grades.

Consideration of a potential driveway access to Wellandport Road will be considered through the Site Plan process.

- d) Access to a Provincial Highway, a Regional road or a local road shall be in accordance with the access provisions of the appropriate road authority.

Consideration of a potential driveway access to Wellandport Road will be considered through the Site Plan process.

- e) Consents will not be granted when any parcel involved requires access to be obtained where a traffic hazard would be created because of limited sight lines on curbs or grades or in proximity to intersections. The geometric and safety requirements of the applicable road authority shall apply.

Existing accesses are present for 5357 and 5377 Elcho Road. No concerns with their current locations or functions have been identified.

- f) Consent will be granted only when it has been established that for all parcels involved, soil and drainage conditions are suitable to permit the proper siting of a building, to obtain a sufficient and potable water supply where applicable and permit the installation of an adequate means of sewage disposal. Consents requiring installation of septic tank systems, or other private sewage disposal systems will meet appropriate standards of the Ontario Building Code.

No additional private servicing infrastructure will be required to support the expansion of 5377 Elcho Road.

A Functional Servicing Report prepared by Upper Canada Consultants outlines the proposed method for managing stormwater on Parts 1 and 2.

- g) Consent will be granted only when confirmation of sufficient reserve sewage system capacity and reserve water system capacity within municipal sewage services and municipal water services.

This policy applies to urban consents, and is not applicable to these applications.

- h) No land severance shall be permitted in any hazardous area that is subject to flooding, erosion or steep slopes except for a severance, which meets the satisfaction of the Ministry of Natural Resources or the Niagara Peninsula Conservation Authority. This may include a requirement for an adequate setback from stable top of slope.

There are no slope features on the subject lands. This policy is not applicable.

- i) No land severance shall be permitted unless adequate lot grading and drainage can be addressed. Further, no land severance shall be permitted unless drainage can be properly outlet from the area, without impacting neighbouring properties, to the satisfaction of the Township.

A provisional site grading design prepared by Upper Canada Consultants has been provided with the application. This Plan demonstrates that through the utilization of a wet pond facility that the expansion lands and retained parcel will continue to drain appropriately to the roadside ditches with no impact on adjacent properties or downstream area.

- j) Any consent will be required to conform with the policies of this plan and the provisions of the Zoning By-law.

The required Zoning By-law Amendment is proceeding for consideration prior to the Consent Application. This Amendment will establish the necessary zoning provisions to support the intended use of the lands.

- k) Where a consent is granted which does not conform with the Plan or Zoning By-law, the Municipality may appeal the decision to the Ontario Municipal Board.

This policy is acknowledged. The application is deemed to conform with the Official Plan and Zoning By-law, as proposed.

- l) Consents will be permitted for infrastructure corridors and facilities where easements or rights of ways are not feasible.

This policy is not applicable to development proposal.

18.13.2 Agriculture Consent Policies

Agricultural Consent policies pertain to any land division application within any of the subsequent agricultural designations (Good General Agricultural, Unique Agricultural Areas).

An assessment of the policies is provided below. Please note policies 18.13.2 c), e), g) and h) are not applicable to the consent application.

- a) Where the land being conveyed or retained is for agricultural purposes, consent may be granted where both the severed and the retained parcels respect the need for long term

agricultural flexibility. In determining if the land is to be used for agricultural purposes, the following criteria will be met:

- i. Agriculture must be the intended use of the lands being retained and severed;
- ii. Smaller lot severances for greenhouses can be permitted subject to the condition that any new dwellings on the property are allowed only after the greenhouse and other farm buildings have been constructed or substantially completed. It is important that small lot severances for greenhouse operations be of sufficient size so that these ample room for future purposes.

The retained land will continue to be used for agricultural purposes. The resultant lot area is considered to be adequate for regular farming practices.

- b) Where the land being conveyed or retained is for a commercial or industrial use which is related to the processing of agricultural products or the servicing of farms and is required in proximity to farms, a consent may be granted subject to the agriculture policies of this plan as they apply to Agriculture Commercial and Industrial Uses.

The proposed Zoning By-law Amendment and Consent application both seek to facilitate the expansion of existing agriculture-related commercial land uses. As demonstrated throughout this report, the applications conform to the relevant policies of the Official Plan.

- d) Where the land being conveyed is to be added to an abutting, existing nonfarm use, consents will be allowed provided that a minimum amount of productive agricultural land is involved and the conveyance is for legal or technical reasons.

The proposed boundary addition will add 2.03 hectares of agricultural land to 5377 Elcho Road, which contains non-farm uses. Based on the large-scale nature of the materials and products on the site (i.e. equipment, pipe, drains, cisterns, septic tanks), the proposed expansion area is the minimum land area that the businesses will require to support their needs.

- f) Where land is being conveyed as part of a minor boundary adjustment, which do not result in the creation of a new lot, consent applications are permitted for legal or technical reasons.

The severance is a boundary adjustment application that does not result in the creation of a new lot. The technical nature of the consent is the reasonable expansion of existing agriculture-related commercial uses within the agricultural area.

TOWNSHIP OF WEST LINCOLN ZONING BY-LAW (By-law No. 2017-70)

Map E7 of Schedule A of Township of West Lincoln Zoning By-law 2017-70 (**Figure 15**) shows 5357 Elcho Road zoned as “Agricultural” (A), “Environmental Protection Area” (EP), and “Environmental Conservation Area” (EC).

The adjacent property known as 5377 Elcho Road is zoned as “Service Commercial” (C3).

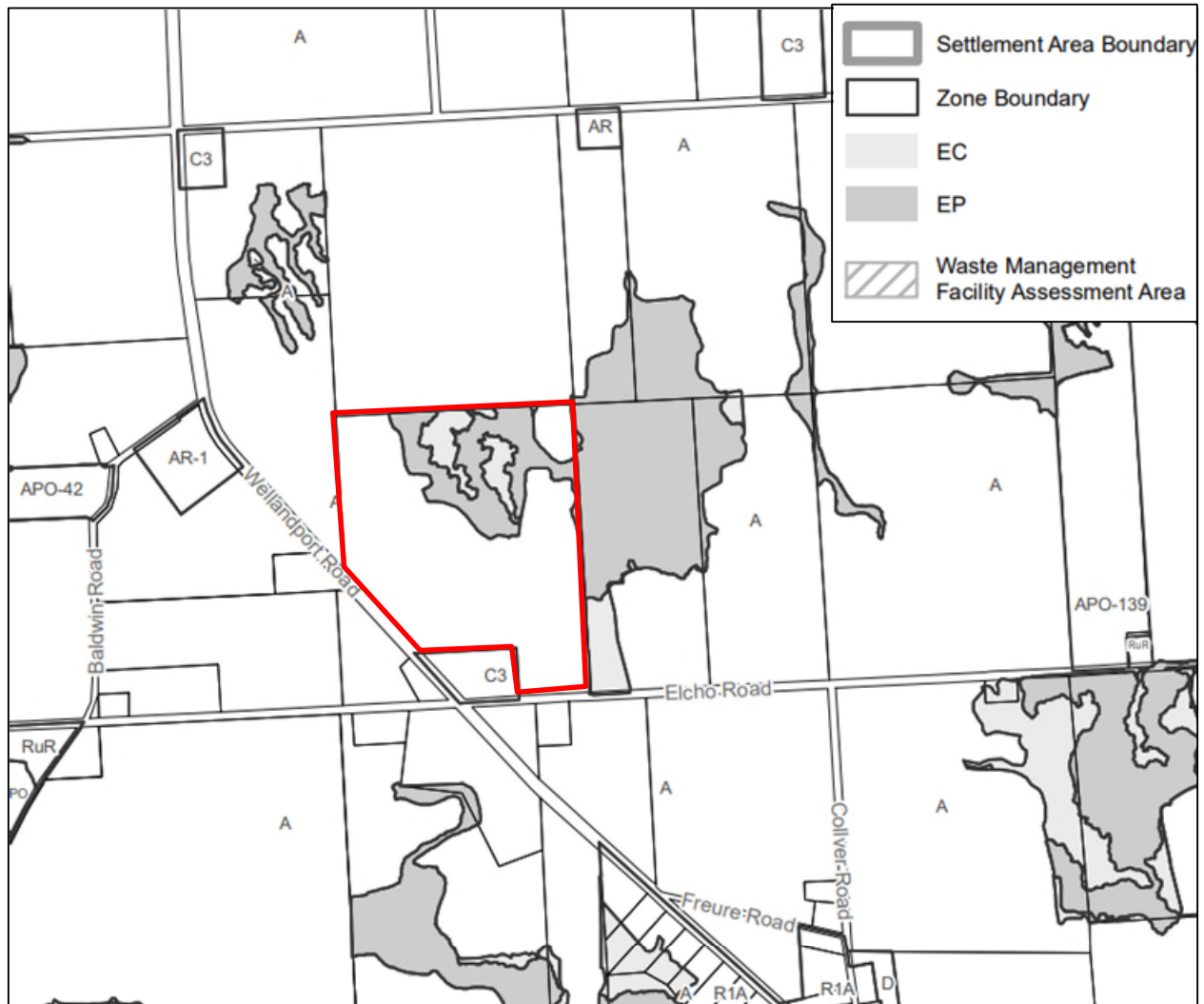

Figure 15 – Schedule A, Map E7 of Zoning By-law 2017-70

The Agricultural (A) Zone that is currently applicable to the expansion lands (Part 2) permits agricultural uses, single detached dwellings, wayside pits and quarries and accessory uses. The subject lands are operating in conformity with the Zoning By-law, as the lands are partially farmed and contain a lawfully established single detached dwelling.

As noted, the introduction of any commercial use, requires a Zoning By-law Amendment. The property known municipally as 5377 Elcho Road is zoned Service Commercial (C3). As shown in Table 1, the C3 zone permits a wide variety of commercial uses. An expansion of this zone and subsequent permissions and provisions is proposed for Part 2, which is 2.03 hectares in area. When merged, the C3 Zoning will apply to 4.03 hectares of land, being the entire consolidated property.

Site Specific Provision for Part 3 (A-X Zone)

The remnant Parcel (Part 3, 5357 Elcho Road) will require a site-specific provision to be added to the applicable Agricultural (A) Zone to permit a minimum lot area that is less than that required Table 12 of Section 5.3 of the Zoning By-law which is 40 hectares.

It is noted that 5357 Elcho Road is already undersized under the requirements of the Zoning By-law, being 32.68 hectares in size rather than the required 40 hectares.

As shown on the provided severance sketch, the resultant lot area after severance will be 30.65 hectares. This minor reduction in lot area is not anticipated to have any significant impact on the ability of the land owner to continue to farm their property.

The proposed Zoning Matrices are reflective of the state of the properties after severance and merger.

Outside Storage

The primary reason for the lot adjustment is due to the need for more storage space for inventory at 5377 Elcho Road. The existing property is currently exceeding the 5% maximum storage provision.

In keeping with the direction of the Zoning By-law, screening can and will be provided along the western exterior side yard flankage. The material and type are able to be determined through detailed site design and may include fencing, berms or landscape – or a mix of all forms.

The preliminary Site Plan shows the general area used for inventory storage on the subject lands, which equates to 56.4%. This area and percentage have been proposed through the zoning amendment.

Table 1: Zoning Compliance Table – Service Commercial (C3) Zone – 5377 Elcho Road (After Merged)

Provision	Required	Proposed
<p>7.2 Permitted Uses</p>	<p>Commercial Kennel Commercial School Communications Establishment Contractors Establishment Drive Through Facility Dry Cleaning / Laundry Depot Financial Institution Funeral Home Garden Centre Hotel/Motel Motor Vehicle Dealership Motor Vehicle Gasoline Bar Motor Vehicle Repair Establishment Motor Vehicle Service Station Motor Vehicle Washing Establishment Office, Including Medical Office Personal Service Shop Pet Care Establishment Place of Entertainment Private Club Recreation Facility Restaurant Retail Store Service Shop Studio Veterinary Clinic Wayside Pit or quarry Accessory Buildings and Structures Outside Display and Sales Area</p>	<p>Contractors Establishment, Service Shop, Outdoor Storage</p>

Provision	Required	Proposed
	Outside Storage Renewable Energy System	
7.3 Regulations	Required	Proposed
Minimum Lot Area	750 m ²	40,300 m ²
Minimum Lot Frontage	25 metres	128.93m
Minimum Front Yard (Elcho Road)	9 metres	36.63m
Minimum Exterior Side Yard (Wellandport Road)	6 metres	83.13m
Minimum Interior Side Yard	6 metres	23.84m
Minimum Rear Yard	6 metres	116.27m
Maximum Lot Coverage	50%	2.2%
Maximum Height	10 Metres	8.5 metres (existing buildings)
Minimum Landscaped Open Space	10%	17.6%
Maximum Outdoor Storage	5% of Lot Area (Outside storage for purposes other than outside display and sales areas on the lot shall be located in a rear yard or side yard and screened from view from public streets and adjacent lots.)	56.4%
Maximum Gross Leasable Floor Area	50%	2.28%
Section 7.1	Required	Proposed

Provision	Required	Proposed
Parking Requirements		
Commercial Retail Use	1 Space per 30 square metres of gross floor area. = 32 spaces required	37 spaces

Table 2: Zoning Compliance Table – Agricultural (A) Zone – 5357 Elcho Road (Dwelling and Farm)

Provision	Required	Proposed
5.2 Permitted Uses	Agricultural Use Single Detached Dwelling Wayside Pit or Quarry	Agricultural Use and Single Detached Dwelling
5.3 Regulations	Required	Proposed
Minimum Lot Area	40 ha	30.65
Minimum Lot Frontage	100 m	171.65 m
Minimum Front Yard (Dwelling)	15 m	62.96 m
Minimum Exterior Side Yard (Dwelling)	15 m	N/A
Minimum Interior Side Yard (Dwelling)	5 m	25.64 m
Minimum Rear Yard (Dwelling)	15 m	±600 m
Maximum Lot Coverage	50%	±0.18%
Maximum Height	15 m	As existing
Minimum Landscaped Open Space	No Minimum	N/A
Maximum Outdoor Storage	5% of Lot Area	None
Section 7.1 Parking Requirements	Required	Proposed
Detached Dwelling	2 Parking Spaces per Dwelling Unit	+ 2 spaces

PLANNING POSITION

Based on the analysis provided within this report the proposed amendment is consistent with the 2020 Provincial Policy Statement and conforms to the 2020 Growth Plan for the Greater Golden Horseshoe, 2022 Niagara Official Plan and Town of West Lincoln Official Plan, as amended.

It is my professional opinion that the applications are representative of good land use planning, are in the public interest, and should be supported by the Township.

Respectfully Submitted,

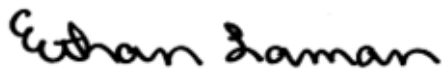
A handwritten signature in black ink that reads "Ethan Laman". The signature is written in a cursive, slightly slanted style.

Ethan Laman, MCIP, RPP

Planner

Upper Canada Consultants

Appendix I
Site Plan



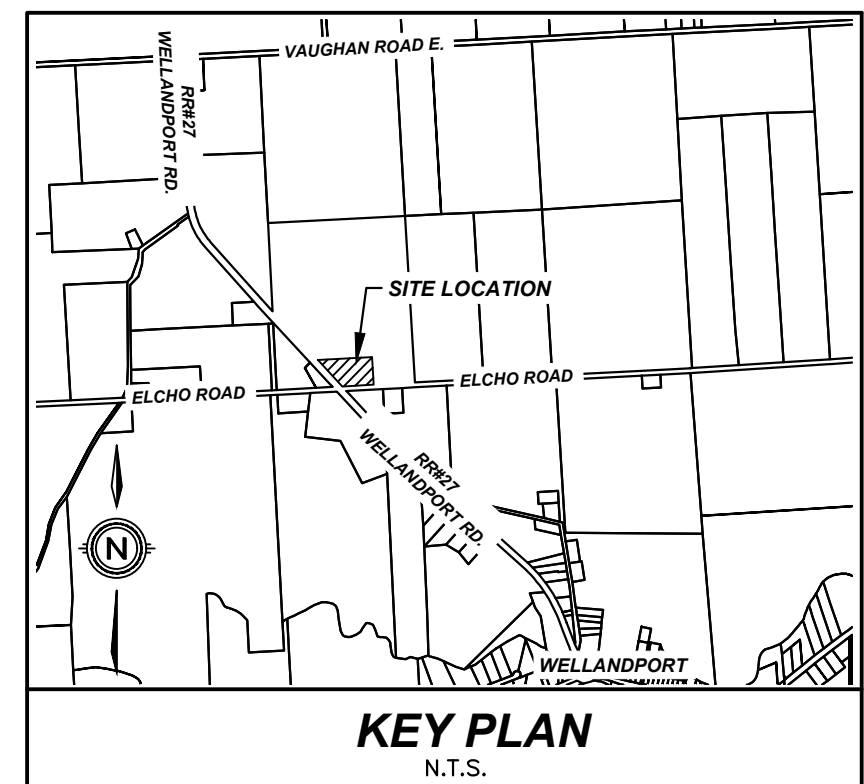
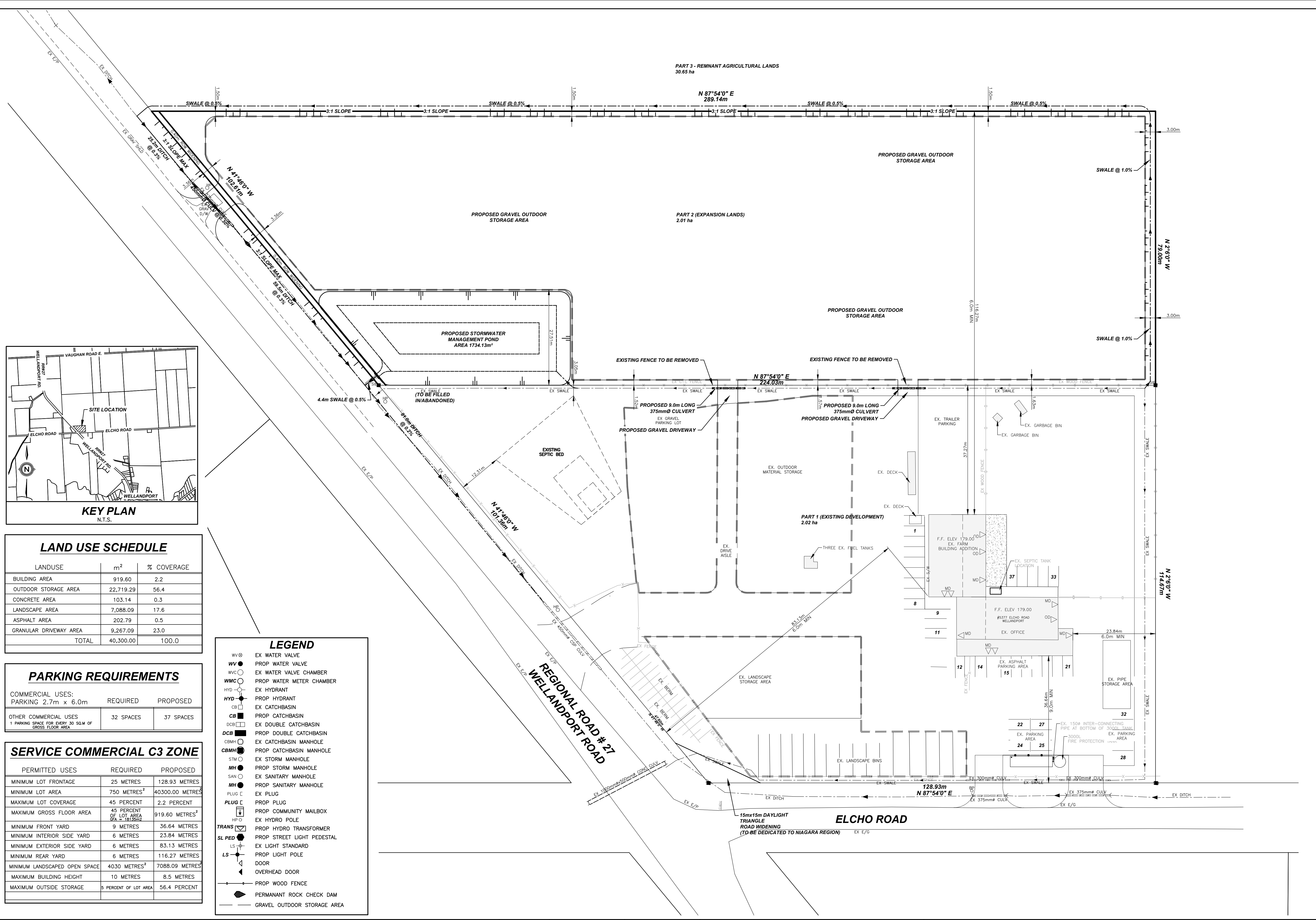
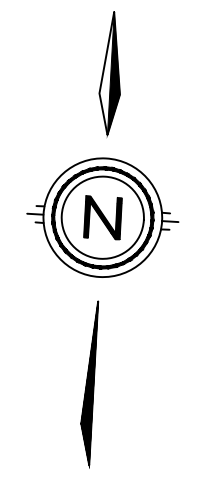

LAND USE SCHEDULE

LANDUSE	m ²	% COVERAGE
BUILDING AREA	919.60	2.2
OUTDOOR STORAGE AREA	22,719.29	56.4
CONCRETE AREA	103.14	0.3
LANDSCAPE AREA	7,088.09	17.6
ASPHALT AREA	202.79	0.5
GRANULAR DRIVEWAY AREA	9,267.09	23.0
TOTAL	40,300.00	100.0

PARKING REQUIREMENTS

COMMERCIAL USES:	REQUIRED	PROPOSED
PARKING 2.7m x 6.0m		

OTHER COMMERCIAL USES
1 PARKING SPACE FOR EVERY 30 SQ.M OF GROSS FLOOR AREA

32 SPACES	37 SPACES
-----------	-----------

SERVICE COMMERCIAL C3 ZONE

PERMITTED USES	REQUIRED	PROPOSED
MINIMUM LOT FRONTAGE	25 METRES	128.93 METRES
MINIMUM LOT AREA	750 METRES ²	40300.00 METRES ²
MAXIMUM LOT COVERAGE	45 PERCENT OF LOT AREA	2.2 PERCENT
MAXIMUM GROSS FLOOR AREA	45 PERCENT OF LOT AREA (GFA = 18135m ²)	919.60 METRES ²
MINIMUM FRONT YARD	9 METRES	36.64 METRES
MINIMUM INTERIOR SIDE YARD	6 METRES	23.84 METRES
MINIMUM EXTERIOR SIDE YARD	6 METRES	83.13 METRES
MINIMUM REAR YARD	6 METRES	116.27 METRES
MINIMUM LANDSCAPED OPEN SPACE	4030 METRES ²	7088.09 METRES ²
MAXIMUM BUILDING HEIGHT	10 METRES	8.5 METRES
MAXIMUM OUTSIDE STORAGE	5 PERCENT OF LOT AREA	56.4 PERCENT

LEGEND

- WV ○ EX WATER VALVE
- WV ● PROP WATER VALVE
- WC ○ EX WATER VALVE CHAMBER
- WMC ○ PROP WATER METER CHAMBER
- HYD ○ EX HYDRANT
- HYD ● PROP HYDRANT
- CB □ EX CATCHBASIN
- CB ■ PROP CATCHBASIN
- DCB □ EX DOUBLE CATCHBASIN
- DCB ■ PROP DOUBLE CATCHBASIN
- CBMH ○ EX CATCHBASIN MANHOLE
- CBMH ● PROP CATCHBASIN MANHOLE
- STM ○ EX STORM MANHOLE
- STM ● PROP STORM MANHOLE
- SAN ○ EX SANITARY MANHOLE
- SAN ● PROP SANITARY MANHOLE
- PLUG E EX PLUG
- PLUG ● PROP PLUG
- HP ○ EX HYDRO POLE
- HP ● PROP HYDRO POLE
- TRANS ○ EX TRANSFORMER
- SL PED ○ EX STREET LIGHT PEDESTAL
- LS ○ EX LIGHT STANDARD
- LS ● PROP LIGHT STANDARD
- DOOR ○ EX DOOR
- OVERHEAD DOOR ○ EX OVERHEAD DOOR
- PROP WOOD FENCE ○ EX PROP WOOD FENCE
- PERMANENT ROCK CHECK DAM ○ EX PERMANENT ROCK CHECK DAM
- GRAVEL OUTDOOR STORAGE AREA ○ EX GRAVEL OUTDOOR STORAGE AREA

NOTES:

- THE POSITION OF POLE LINES, CONDUITS, WATERMANS, SEWER, AND OTHER UNDERGROUND AND OVERGROUND UTILITIES AND STRUCTURES IS NOT NECESSARILY SHOWN ON THE CONTRACT DRAWINGS AND, WHERE SHOWN, THE ACCURACY OF THE POSITION OF SUCH UTILITIES AND STRUCTURES IS NOT GUARANTEED. BEFORE STARTING WORK, THE CONTRACTOR SHALL INFORM HIMSELF OF THE EXACT LOCATION OF ALL SUCH UTILITIES AND STRUCTURES AND SHALL ASSUME ALL LIABILITY FOR DAMAGE TO THEM.
- PROPERTY LINES WERE PLOTTED USING REGISTERED PLANS AND BARS LOCATED IN THE FIELD, TO VERIFY THE ACCURACY OF THESE PROPERTY LINES, A LEGAL SURVEY SHOULD BE PERFORMED PRIOR TO CONSTRUCTION.
- ALL CONSTRUCTION MUST COMPLY WITH THE NIAGARA PENINSULA STANDARD CONTRACT DOCUMENT.

DRAFTING	M.C.
DESIGN	J.S.
CHECKED BY	J.S.
APPROVED BY	



OWNER
NGF PROPERTY INC.
5377 ELCHO ROAD
WEST LINCOLN, ON

**#5377 ELCHO ROAD
WELLANDPORT
SITE PLAN**

CONSULTANT FILE No.	2089
DATE	2024-04-04
PRINTED	2024-04-04
SCALE	1:400 m
REF No.	
DWG No.	2189-SP
REV	0

#	REVISION	DATE	INIT
0	ISSUED FOR CLIENT REVIEW	2021-12-02	M.C.

Appendix II
Pre-consultation Notes

Pre-consultation Meeting Form

Persons intending to make an application for a proposed development are required to consult with planning staff prior to submitting an application. A pre-consultation meeting will identify what is required to be submitted for a complete application and will provide the opportunity to discuss:

- the nature of the application;
- development and planning issues;
- fees;
- the need for information and/or reports to be submitted with the application;
- the planning approval process;
- other matters, as determined.

Individuals who make written submissions with respect to a Planning Act application should be aware that their submission and any personal information in their correspondence will become part of the public record and made available to the Applicant, Committee and Council.

Pre-Consultation Meeting Date: May 3, 2023

Site Address: 5357 & 5377 Elcho Road **Approximate Land Area (metric):** 2 hectares and 32.7 hectares

Site Legal Description: Concession 2, Part Lot 13, RP 30R2450 Part 2

Owner Contact Information:

Name of Owner: Brad and Kimberly Killins & NGF Property Inc.

Phone Number: _____ Email: _____

Principal Contact: Craig Rohe – Upper Canada Consulting

Phone Number: _____ Email: _____

Application Type:

- Official Plan Amendment (OPA)
- Zoning Bylaw Amendment (ZBA)
- Combined OPA/ZBA
- Consent – Severance to Create New Lot Boundary Adjustment Consent – Easement
- Minor Variance
- Site Plan
- Draft Plan of Subdivision
- Draft Plan of Condominium – Standard Vacant Land Common Element

Local Municipal Contact: Gerrit Boerema **Phone:** 905-957-5133 **Email:** gboerema@westlincoln.ca

1. Brief description of proposed development:

The owners of 5357 and 5377 Elcho Road are requesting a consent/boundary to sever 5 acres of farmland from 5357 Elcho Road and add it to 5377 Elcho Road, a 5 acre commercially zoned lot which contains an agricultural service and supply establishment.

2. Check All Applicable: Brownfield Greenfield Built-up Greenbelt Local CIP Area

3. Development Charges: Regional By-law 62-2012, Local By-law 2009-63

4. Existing Regional Policy Plan Designation: Prime Agricultural Lands

Conformity with Regional Policy Plan land use designations and policies? : Yes No

If 'No', what is the nature of the amendment needed? _____

5. Existing Local Official Plan Designation: Good General Agriculture

Conformity with Official Plan land use designations and policies? Yes No

If 'No', what is the nature of the amendment needed? See TWP Planning Comments below.

6. Existing Zoning: Agricultural 'A' (proposed severed parcel) and Commercial 'C3' (receiving parcel)

Conformity with existing zoning?: Yes No

If 'No', what is the proposed zoning: Remaining agricultural lands will not meet the minimum lot area and severed lot will need to be rezoned to permit additional uses.

7. Urban Design Guideline Applicable? Yes No

8. Is Site Plan approval required? Yes No

9. Open House Required? Yes No

10. Fees Required at time of Submission of the Application

Application	Township Planning Department	Region of Niagara	Niagara Peninsula Conservation Authority	Other Fees
Regional Policy Plan Amendment				
Local Official Plan Amendment				
Zoning By-law Amendment	\$4,820.00	\$1,395.00		
Plan of subdivision				
Plan of Condominium				
Consent	\$1,480.00	\$940.00		
Site Plan Control or Amendment	\$8,470.00	\$570 + 675.00		
Other				
Pre-con fee deposit	- \$310.00*			
TOTAL				

Notes on Fees:

- Notwithstanding the fees noted above, all fees are payable based upon the rate in the fee schedule by-law in effect on the date the application is received.
- Further fees may be required at a later date as per the fee schedule by-law.
- Separate cheques shall be made payable to the appropriate agency.
- In addition to all application fees set out above, the applicant shall pay to the Township prior to final approval, all peer review fees, engineering review costs and legal fees incurred by the Township in reviewing the application.
- *\$255 to be taken off of one application fee if applied for within one year.

11. Development Charges (if applicable)

	Township Fee Rate	Region of Niagara Fee Rate	Notes
Building Permit Fee			
Conditional Permit (if applicable)			
Municipal Development Charge			
Site Specific Development Charge - Sanitary			
Site Specific Development Charge - Storm			
Site Specific Development Charge - Water			
Development Charge Credits			
Other			
TOTAL			

12. Additional Agencies to be contacted:

- HYDRO PIPELINES OTHER _____

13. Additional Comments:

TOWNSHIP PLANNING The subject lands are within the Good General Agricultural Designation. The Good General Agricultural policies can be found in Section 4 of the Township's Official Plan and severance policies can be found in Section 18 of the Official Plan. Township staff note the specific application of Policies 4.4.2 b), e) and g), namely ensuring that agricultural lots remain of a large enough size to ensure flexibility for future agricultural operations, ensuring that small scale commercial and industrial uses remain small in scale to minimize the impact on existing and future agricultural operations and that changes to existing non-agricultural uses shall require additional approvals such as zoning amendments and site plan approval. The Township further provides policies in Section 1813.2 a), b) and d). In summary, the policy can support farm land being added to a non-farm use if the minimum amount of productive agricultural farmland is taken out of production. Additionally, boundary adjustments are permitted for legal and technical reasons, including minor boundary adjustments. Staff are concerned that a doubling of the existing lot is not minor, and consumes a large amount of agricultural land, which may have impacts on future farming flexibility of the remaining farm land and may impact surrounding agricultural lands. Staff will need a planning justification report to support the consent, but would be in a better position to support a consent if the land being added was lessened by half. This would reduce the amount of farmland being taken out of production and help keep the business smaller in scale and help the boundary adjustment be considered minor. Staff additionally note the Niagara Official Plan policy 4.1.10 Non Conforming Uses in the Agricultural System. This policy allows for expansions of non-conforming uses provided it meets a number of criteria. Township Planning staff would be looking for justification on this policy as well. In summary, Planning Staff are requesting that:

- The area be reduced
- Planning Justification be provided on applicable policies mentioned above
- Detailed description of the current and proposed use(s) and how, if it does, relates to agriculture
- Impact on future flexibility of farm property

The subject property is also zoned Agricultural 'A'. A zoning amendment or variance will be required as the lot will become further deficient of the minimum lot area of 40 hectares. The severed lands will also need to be rezoned to allow for the proposed use. Planning staff prefer a zoning of Agricultural Related, however, split zonings do pose issues with respect to enforcement. The zoning should also address outdoor storage limitations as most of the property is being used for outdoor storage.

As the proposal is for a commercial/ag related use, the site plan will need to be updated to reflect the new boundaries. The site plan should also consider features to increase compatibility with surrounding agricultural lands, such as fencing and vegetation planning.

REGION OF NIAGARA

Planning Comments

- An agricultural system has been identified in which all types, sizes and in intensities of agricultural uses and normal farm practices shall be promoted and protected in accordance with Provincial standards. In addition, agriculture-related uses and on-farm diversified uses are permitted within the Prime Agricultural Area.
- NOP Policy 4.1.10.1 does not prohibit the continued operation of legally established commercial uses. The proposed expansion would require agricultural land from the adjacent property (5357 Elcho Road) be added to the commercial property at 5377 Elcho Road. NOP Policy 4.1.10.2 outlines that expansions to existing buildings and structures, accessory structures and existing uses in the Agricultural System are permitted subject to the following:
 - new municipal services are not required;
 - the proposal does not expand into *key natural heritage features* and *key hydrologic features*, unless there is no other alternative in which case any expansion shall be limited in scope and kept within close geographical proximity to the existing structure;
 - the proposal does not result in the intrusion of new incompatible uses; and

- the proposed use is in accordance with the *minimum distance separation formulae*.
- NOP Policy 4.1.3.7 identifies that where agricultural uses and non-agricultural uses interface, land use compatibility shall be achieved by avoiding or, where avoidance is not possible, minimizing and mitigating adverse impacts on the agricultural system, by incorporating measures as part of expanding non-agricultural uses, as appropriate, within the area being developed.
- To facilitate the expansion, a lot boundary adjustment is proposed. Policy 4.1.6.1 d) in the NOP allows for lot adjustments for legal or technical reasons, which includes minor boundary adjustments that do not result in the creation of a new lot.
- Staff are concerned with the size of the proposed expansion (doubling the commercial property). Staff recommend the proposal be scaled back in order to be considered 'minor' in alignment with PPS and NOP lot creation policies.
- For the proposed expansion of the legally existing commercial business staff require a Planning Justification Report prepared by a Registered Professional Planner to justify how the proposal aligns with relevant Regional and Provincial policies as detailed above. This should include analysis of how land use compatibility between the commercial expansion and surrounding agricultural operations/lands can be achieved.

Archaeological Potential

- 5357 Elcho Road is mapped as an area of Archaeological Potential on Schedule K of the NOP. Policy 6.4.2.6 of the NOP requires the submission of a Stage 1 Archaeological Assessment (at minimum) by a licensed archaeologist for any development and/or site alteration within an area of archaeological potential.
- As such, staff will require a Stage 1 Archaeological Assessment (at minimum) by a licensed archaeologist for the proposed expansion into 5357 Elcho Road. The assessment must be accepted by the Ministry of Citizenship and Multiculturalism (MCM) with a copy shared to Niagara Region. Note, according to Policy 6.4.2.6, lands located outside a *settlement area* boundary where *site alteration* or *development* will not affect the entire property, may be scoped by the licensed archaeologist in consultation with the Province.

Environmental Comments

- The subject property is impacted by the Region's Natural Environment System (NES), consisting of Provincially significant wetland (PSW), significant woodland, other wetlands, permanent or intermittent watercourse and a linkage. Wetlands and watercourses are considered Key Hydrologic Features (KHF) outside of settlement areas.
- Niagara Official Plan (NOP) policies requires the completion of an Environmental Impact Study (EIS) when development or site alteration is proposed within 120 m of KHFs/Significant Woodland and within 30 m of a linkage.
- The proposed development is outside of the above-noted setbacks. As such, staff offer no requirements.

Transportation / Roads

- Elcho Road – Local
- Wellandport Road (RR #27) - Regional

Road Widening

- The current width of Regional Road #27 (Wellandport Road) is approximately 30.5 m. This exceeds the Policy Width of 26.2 m. Therefore, no additional widening would be required.
- A 15m x 15 m daylight triangle is required at the corner of Wellandport Road and Elcho Road.



Regional Permit Requirements

- Regional transportation planning and operations staff are okay with the conceptual regrading proposed, if swales along the perimeter are not on the subject property. The owner shall provide consent from adjacent owners for the proposed works. Detailed comments will be provided at the site plan stage
- The Owner is to confirm that the existing and proposed culverts will be sufficiently sized to accommodate the proposed flows.
- Require Regional Construction Encroachment and Entrance Permit prior to any construction within Regional Road Allowance.
- Regional Sign Permit Required for any signs within 20m of the centreline on Wellandport Road
- Permit link: <https://www.niagararegion.ca/living/roads/permits/default.aspx>

Restoration is to be to Regional standards: <https://www.niagararegion.ca/living/roads/permits/construction-encroachment-specifications.aspx>

Servicing Comments

- Water: Private
- Sanitary: Private
 - Private servicing requirements under jurisdiction of Township
- Storm: Roadside Ditches

Stormwater Management Comments

- At the time of future Planning Act Application (i.e. Draft Plan and/or Site Plan), the Region will require a stormwater management plan be reviewed. The following comments are provided for information to assist the applicant with the preparation of a detailed site plan:
 - The Niagara Region will require that stormwater runoff from a 25mm design storm event be captured and released over a period of 24 hours in order to mitigate the erosion impacts to the downstream watercourse
 - The Niagara Region will require that stormwater runoff from the development be captured and treated to enhance protection (i.e. 80% long-term suspended solids removal) prior to discharge from the site.
 - The Niagara Region will require Wellandport Road (Regional Road 27) not be negatively affected as a result of the development. The Region normally requires post-development flows be controlled to pre-development level for all storms (2-year up to and including the 100-year storm) if a development will discharge onto a Regional Road.
 - The Niagara Region will require that a stormwater management report (and the associated fee) be submitted to this office indicating in details how the above noted criteria will be achieved and including a section of inspection and maintenance requirements of SWM measures for the future owner.
 - Prior to construction, the Niagara Region will require that detailed grading, servicing and construction erosion/sediment control plans be submitted to this office for review and approval.

Waste Collection

- Niagara Region provides curbside waste and recycling collection for developments that meet the requirements of Niagara Region's Waste Collection Policy. The subject property is eligible to receive Regional curbside waste and recycling collection provided that the owner bring the waste and recycling to the curbside on the designated pick up day, and that the following limits are met:

5357 Elcho Road (Residential)

- Blue/grey – no limit (weekly)
- Green – no limit (weekly)
- Waste – 2 bag/can limit (bi-weekly)
- Curbside collection only
- Collection to remain as is.

5377 Elcho Road (Commercial)

- Blue/grey – max. 8 blue/grey carts (weekly)
- Green – unlimited green bins / max. 8 green carts (weekly)
- Waste – 8 bag/can limit (bi-weekly)
- Curbside collection only
- Collection to remain as is.

Required Studies for Regional Review

- Planning Justification Report (with Zoning/Consent)
- Stage 1 Archeological Assessment Report and MCM acknowledgement letter (with Zoning/Consent)
- Stormwater Management Report (Site Plan)

Required Fees

The Region's 2023 Fee Schedule is available at: https://www.niagararegion.ca/business/fpr/forms_fees.aspx

Applications will be subject to the in-effect fee amounts at the time that the Application is submitted.

<u>Development Application Review Type</u>	<u>Fee Amount</u>
<u>Zoning By-law Amendment Review</u>	<u>\$1,395</u>
<u>Consent Review - Rural / Outside Urban Areas</u>	<u>\$940</u>
<u>Site Plan Review</u>	<u>\$570</u>
<u>Stormwater Review less than 5 ha</u>	<u>\$675 (with Site Plan fee)</u>

NPCA

The subject parcel is outside the NPCA Regulated Area. However, the Agricultural parcel to the north does contain Provincially Significant Wetland (PSW) associated with the Beaver Creek West Lincoln Wetland Complex and is traversed by a section of Beaver Creek which poses a potential flood concern.

Provided the proposed lot addition is greater than 120 metres from the wetland impacting the site, the NPCA is satisfied that an Environmental Impact Study, associated Water Balance Assessment and floodplain mapping requirement can be waived.

TOWNSHIP PUBLIC WORKS

No comments at this time. Will review the site plan application when received.

TOWNSHIP BUILDING

The site should be supplied with adequate water for firefighting.

14. **Site Visit:** _____

15. Incentive Programs:

16. Required Information and Studies to be submitted with the Application(s). Studies identified with an asterisk* will likely require a peer review at the cost of the developer.

Local	Region	NPCA	Reports, Studies, Plans (See Notes for additional details)	No. of Copies		Notes
				Digital	Paper	
✓			Planning Justification Report	✓	5	
✓			Conceptual Site Plan	✓	5	
✓			Survey Sketch	✓	5	
			Draft Regional Policy Plan Amendment			
✓			Draft Local Zoning Amendment Bylaw	✓	5	
			Land Use/Market Needs*			
			Urban Design/Landscape Plans			
	✓		Archaeology Assessment	✓	5	
			Cultural Heritage Impact Assessment*			
			Environmental Impact Study			
			Environmental Planning Study/ Sub-Watershed Study			
			Tree Inventory Preservation Plan			
			Floodplain and Hazard Lands Boundary Plan			
			Geotechnical			
			Environmental Site Assessment			
			Air Quality/Noise & Vibration Study*			
			Agricultural Impact Assessment			
			Farm Operation and Ownership			
✓			Minimum Distance Separation I & II	✓	5	
			Mineral Aggregate Resources			
			Municipal Servicing Study			
			Phasing Plan			
			Sensitive Land Use Report			
			Slope Stability Report			
✓			Stormwater Management Plan	✓	5	
			Transportation Impact Study/Parking Impact Analysis			
			Hydrogeological Study and Private Servicing Plans*			
			Soil report			
			Financial Impact Assessment*			
			Shadow Analysis			
			Risk Management Study			
✓			Gas Well Study/Gas Migration Study	✓	5	Confirmation of existing gas/water wells
			Wind Study*			
✓			Cistern for Fire Purposes under OBC	✓	5	
			Other*			

Notes:

1. The purpose of this document is to identify the information required to commence processing and evaluating an application as set out in the Planning Act. This pre-consultation process is designed to proceed based on the mutual agreement of the parties as shown by the signatures below.
2. Pre-consultation does not imply or suggest any decision whatsoever on behalf of staff or the municipality to either support or refuse the application.
3. The applicant should be aware that the information provided is accurate as of the date of the preconsultation meeting. Should an application not be submitted in the near future, and should other policies, by-laws or procedures be approved by the Province, Municipality, Region or other agencies prior to the submission of a formal application, the applicant will be subject to any new policies, by-laws or procedures that are in effect at the time of the submission of a formal application. If an application is not submitted within 1 year, it is advisable that the applicant confirm with the municipality the directives of the original preconsultation meeting.

4. Any application submitted without the information identified in this Pre-consultation Document will be deemed incomplete and not processed. Alternately, staff may recommend refusal of the application based upon insufficient information to properly evaluate the application.
5. The applicant acknowledges that the Municipality and Region considers the application forms and all supporting materials including studies and drawings, filed with any application to be public information and to form part of the public record. With the filing of an application, the applicant consents and hereby confirms that the consent of the authors of all supporting reports have been obtained, to permit the Municipality and Region to release the application and any supporting materials either for its own use in processing the application, or at the request of a third party, without further notification to, or permission from, the applicant.
6. It is hereby understood that during the review of the application additional studies or information may be required as a result of issues arising during the processing of the application or the review of the submitted studies.
7. If the Municipality or Region does not have sufficient expertise to review and determine that a study is acceptable, the Municipality may require a peer review. The cost of the peer review shall be paid for by the applicant. The Terms of Reference for a peer review is determined by the Municipality or Region.
8. Some studies may require NPCA review and clearance/approval. In this instance, the NPCA review fee shall be paid by the applicant.
9. All plans and statistics must be submitted in metric.
10. It is hereby understood that during the review of the application additional applications, studies or information may be required as a result of issues arising during the processing of the application.
11. There may also be financial requirements arising from the application, including, but not limited to, parkland dedication, development charges, payment of outstanding property taxes, deferred local improvement charges, cost for lifting 0.3 metres reserves, and reimbursement for road widening acquisition or road improvements.
12. Engineering review done in association with an application will be billed to the applicant.

Signatures:

<u>Gerrit Boerema</u> Township Planning Staff	_____	_____
	Township Planning Staff (signature)	Date
_____	_____	_____
Township Public Works Staff	Township Public Works (signature)	Date
_____	_____	_____
Township Building Staff	Township CBO (signature)	Date
<u>Katie Young</u> Regional Staff	_____	_____
	Regional Staff (signature)	Date
_____	_____	_____
Regional Staff	Regional Staff (signature)	Date
_____	_____	_____
NPCA Staff	Conservation Staff (signature)	Date
<u>Craig Rohe</u> Agent	_____	_____
	Agent (signature)	Date
_____	_____	_____
Owner	Owner (signature)	Date
_____	_____	_____
Other	Other (signature)	Date

Appendix III
Draft Zoning By-law Amendment



THE CORPORATION OF THE TOWNSHIP OF WEST LINCOLN

BY-LAW NO. 2024- XX

**A BY-LAW TO AMEND ZONING BY-LAW NO. 2017-70, AS
AMENDED, OF THE TOWNSHIP OF WEST LINCOLN**

WHEREAS the Township of West Lincoln is empowered to enact this By-Law by virtue of the provisions of Section 34 of the Planning Act, 1990, as amended;

NOW THEREFORE, THE COUNCIL OF THE CORPORATION OF THE TOWNSHIP OF WEST LINCOLN HEREBY ENACTS AS FOLLOWS:

1. That Schedule 'A' Map 'E7', as amended, is hereby amended by changing the zoning on the lands municipally known as 5357 and 5377 Elcho Road, in the Township of West Lincoln, Regional Municipality of Niagara, shown as the subject lands on Schedule 'A', attached hereto and forming part of this By-law; and,
2. That Map 'E7' to Schedule 'A' to Zoning By-law No. 2017-70, as amended, is further amended by changing shown on Schedule 'A', attached hereto and forming part of this By-law as follows:
 - Part 1 – From Service Commercial Zone (C3) Zone to Service Commercial Site-specific (C3-XX) Zone
 - Part 2 – From Agricultural (A) Zone to Service Commercial Site-specific (C3-XX) Zone
 - Part 3 – From Agricultural (A) Zone to Agricultural Site-specific (A-XX) Zone
3. That Parts 5 and 7 of Zoning By-Law 2017- 70, as amended, is hereby amended by adding the following to Part 13.2:

A-XX

Permitted Uses:

As per the parent zone.

Regulations:

All regulations of the A zone except:

- a) Minimum lot area of no less than 30.6 hectares

C3-XX

Permitted Uses:

As per the parent zone.

Regulations:

All regulations of the C3 zone except:

a) Maximum Outdoor Storage – 57% of the lot area

4. That all other provisions of By-law 2017-70 continue to apply; and,
5. That this By-Law shall become effective from and after the date of passing thereof.



**READ A FIRST, SECOND AND
THIRD TIME AND FINALLY
PASSED THIS 24 DAY OF JUNE,
2024.**

MAYOR CHERYL GANANN

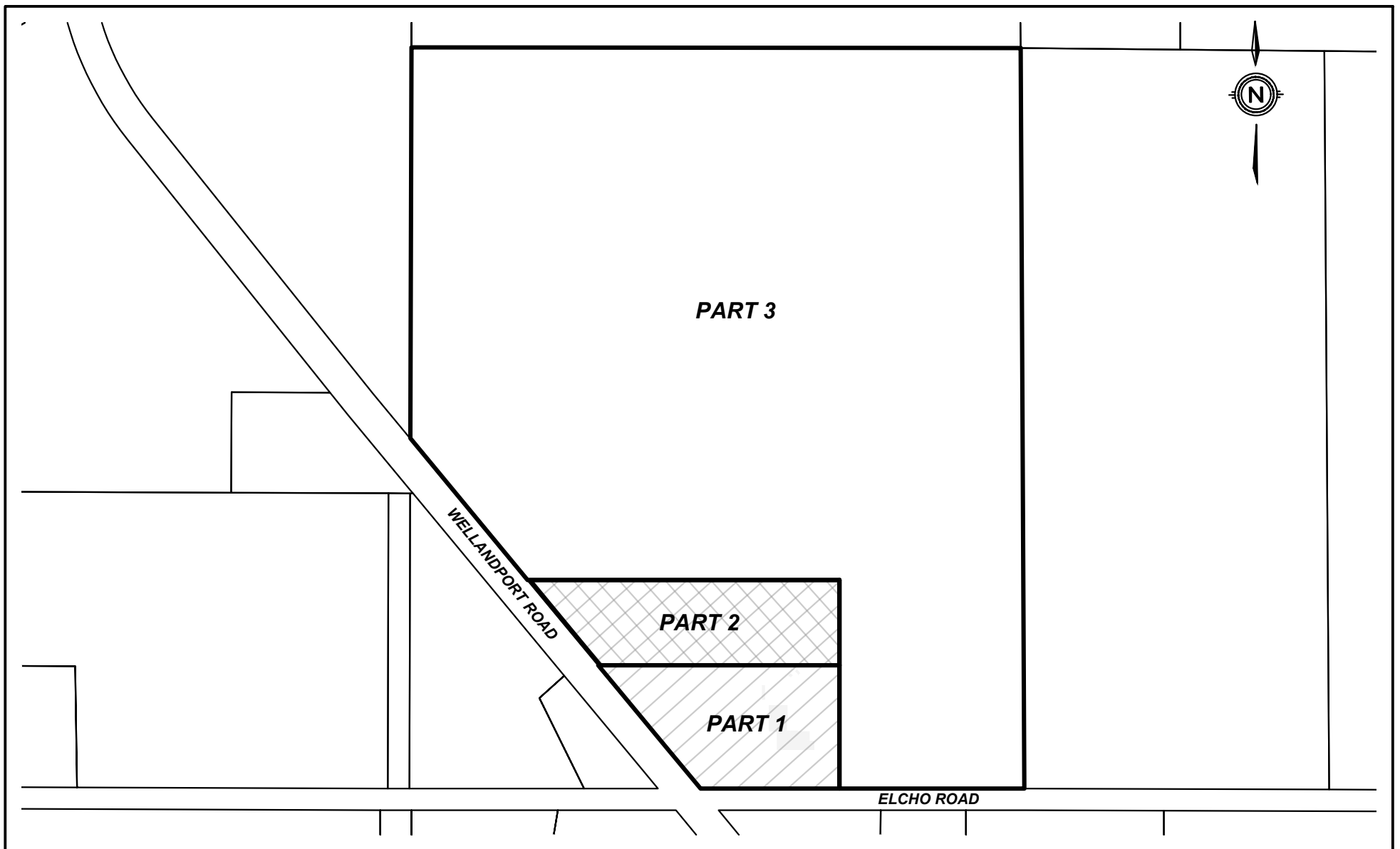
JUSTIN PAYLOVE, CLERK



LEGEND

-  PART 1 - FROM SERVICE COMMERCIAL (C3) ZONE TO SERVICE COMMERCIAL (C3-X) SITE SPECIFIC ZONE
-  PART 2 - FROM AGRICULTURAL (A) ZONE TO SERVICE COMMERCIAL (C3-X) SITE SPECIFIC ZONE
-  PART 3 - TO REMAIN AGRICULTURAL (A) ZONE

#5377 ELCHO ROAD
SCHEDULE 'A' OF ZONING BY-LAW AMENDMENT No. _____

MAYOR: _____
 CLERK: _____



Appendix IV
Preliminary Consent Sketch



SURVEYOR'S SEAL

SKETCH

THIS IS AN ORIGINAL COPY IF EMBOSSED BY THE SURVEYOR'S SEAL, OR PDF CERTIFIED

SKETCH FOR PLANNING ACT APPLICATION 5357 & 5377 ELCHO ROAD TOWNSHIP OF WEST LINCOLN

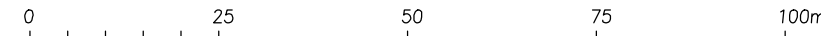

SCALE 1: 1000
RASCH & HYDE LTD.
ONTARIO LAND SURVEYORS

© COPYRIGHT, Rasch & Hyde Ltd., OLS's, 2023

PARCEL 3
30.65 Ha
(TO BE RETAINED)

PART 1 PLAN 30R-2450
SUBJECT TO R-0-W AS IN R0395283
(WIDTH EXAGGERATED FOR CLARITY)
(0.30 WIDE)
PIN 46080-0098 (LT)

PARCEL 2
2.03 Ha
(TO BE SEVERED
AND ADDED TO
PARCEL 1)

PARCEL 1
2.02 Ha

LEGEND & NOTES

- BF DENOTES BOARD FENCE
- CLF DENOTES CHAIN LINK FENCE
- PIN DENOTES PROPERTY IDENTIFIER NUMBER

**BUILDING TIES, DISTANCES AND AREAS ARE APPROXIMATE.

CAUTION

1. THIS IS NOT A PLAN OF SURVEY AND SHALL NOT BE USED EXCEPT FOR THE PURPOSES INDICATED IN THE TITLE BLOCK.
2. THIS SKETCH IS PROTECTED BY COPYRIGHT ©
3. THIS IS NOT AN ORIGINAL COPY UNLESS EMBOSSED WITH THE SURVEYOR'S SEAL, OR PDF CERTIFIED.

BOUNDARY NOTE

BOUNDARIES HAVE BEEN DERIVED FROM REGISTRY OFFICE RECORDS, PLAN 30R-1646, PLAN 30R-2450 AND ACTUAL FIELD WORK.

PROPERTY DESCRIPTION

PART OF THE SOUTH 1/2 OF LOT 13, CONCESSION 2
GEOGRAPHIC TOWNSHIP OF GAINSBOROUGH
TOWNSHIP OF WEST LINCOLN
REGIONAL MUNICIPALITY OF NIAGARA
PIN 46080-0041 (LT) AND PIN 46080-0042 (LT)

METRIC NOTE

DISTANCES SHOWN ON THIS PLAN ARE IN METRES AND CAN BE CONVERTED TO FEET BY DIVIDING BY 0.3048

APRIL 27, 2023
DATE

Harold D. Hyde
HAROLD D. HYDE
ONTARIO LAND SURVEYOR

PIN 46080 - 0071 (LT)
ROAD ALLOWANCE BETWEEN
CONCESSIONS 1 AND 2, GAINSBOROUGH
ALSO KNOWN AS ELCHO ROAD

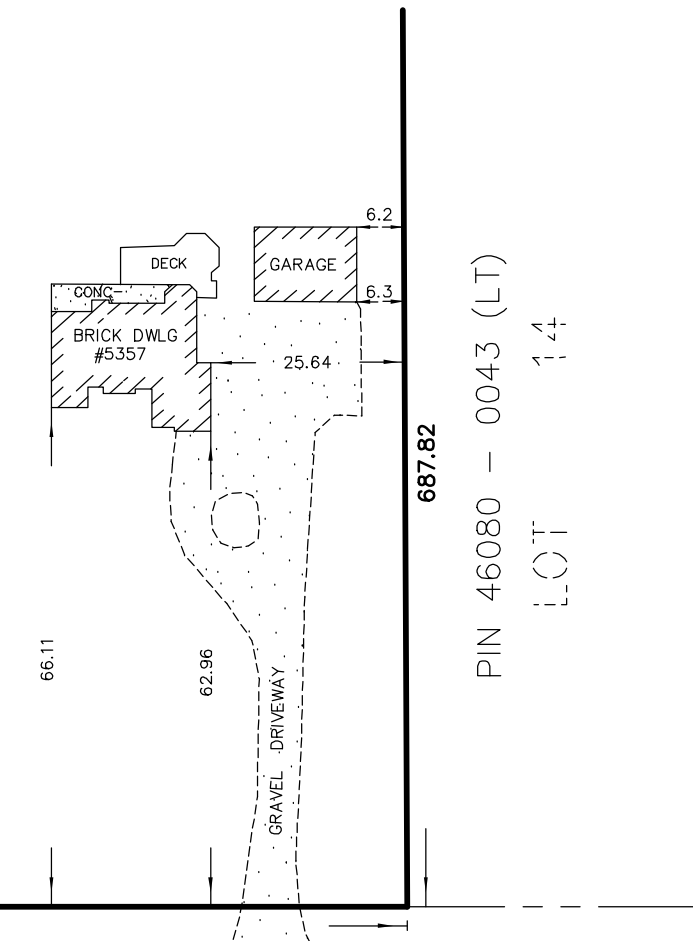
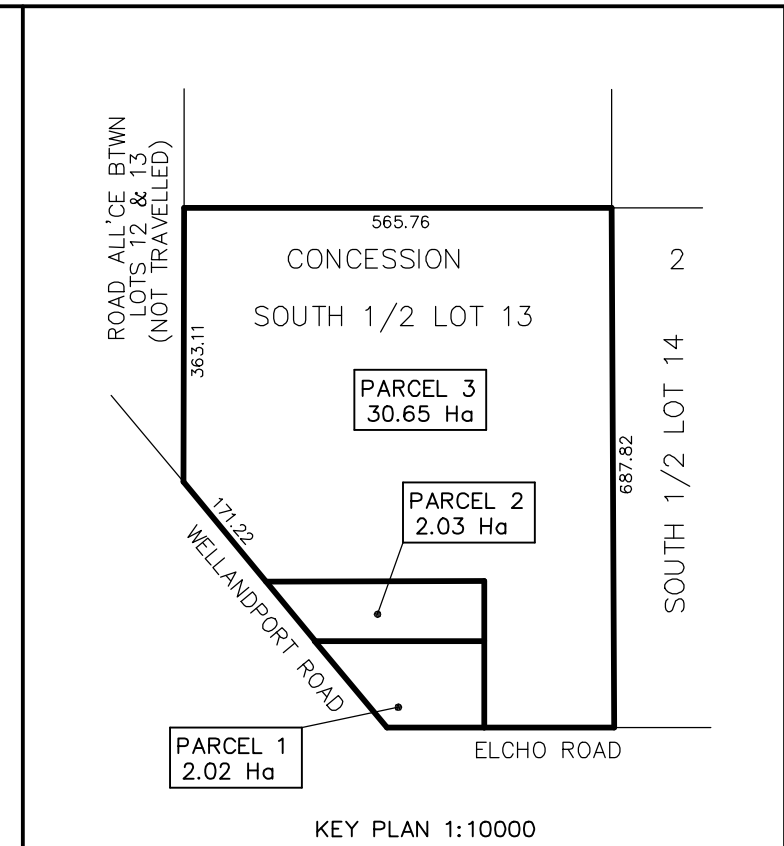
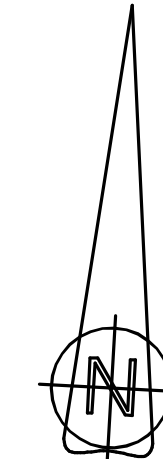

RASCH + HYDE LTD. Ontario Land Surveyors	
P.O. Box 6, 1333 Highway #3 East, Unit B DUNNVILLE, ONT, N1A 2X1 905-774-7188 (FAX 905-774-4000)	P.O. Box 550, 74 Jarvis Street FORT ERIE, ONT, L2A 5Y1 905-871-9757 (FAX 905-871-9748)
HAROLD D. HYDE O.L.S.	
SCALE 1 : 1000	SURVEY : 22-048
DRWN BY : T. Matheson	

Appendix V
Preliminary Grading Plan



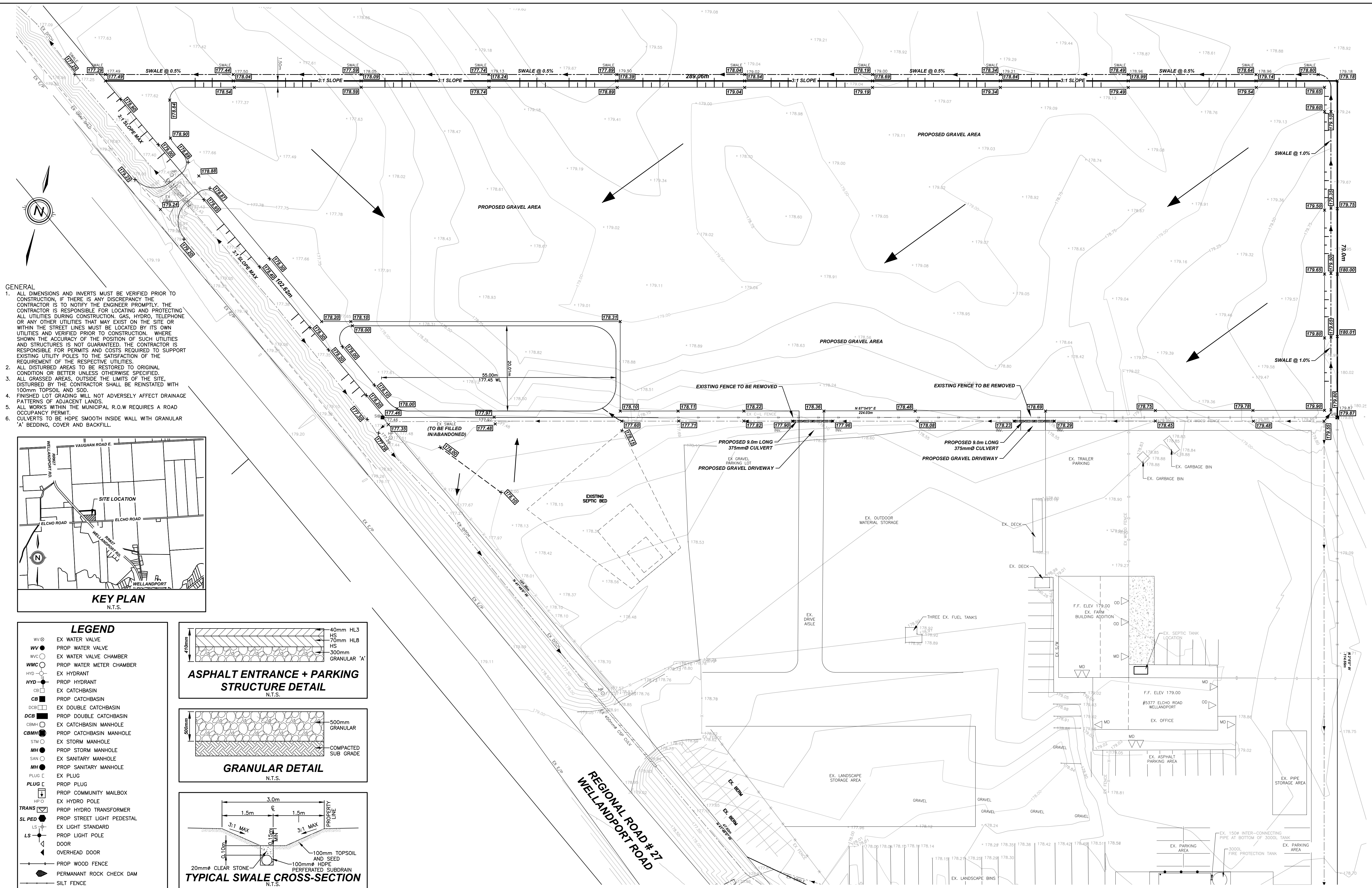

- GENERAL**
1. ALL DIMENSIONS AND INVERTS MUST BE VERIFIED PRIOR TO CONSTRUCTION. IF THERE IS ANY DISCREPANCY THE CONTRACTOR IS TO NOTIFY THE ENGINEER PROMPTLY. THE CONTRACTOR IS RESPONSIBLE FOR LOCATING AND PROTECTING ALL UTILITIES DURING CONSTRUCTION. GAS, HYDRO, TELEPHONE OR ANY OTHER UTILITIES THAT MAY EXIST ON THE SITE OR WITHIN THE STREET LINES MUST BE LOCATED BY ITS OWN UTILITIES AND VERIFIED PRIOR TO CONSTRUCTION. WHERE SHOWN THE ACCURACY OF THE POSITION OF SUCH UTILITIES AND STRUCTURES IS NOT GUARANTEED. THE CONTRACTOR IS RESPONSIBLE FOR PERMITS AND COSTS REQUIRED TO SUPPORT EXISTING UTILITY POLES TO THE SATISFACTION OF THE REQUIREMENT OF THE RESPECTIVE UTILITIES.
 2. ALL DISTURBED AREAS TO BE RESTORED TO ORIGINAL CONDITION OR BETTER UNLESS OTHERWISE SPECIFIED.
 3. ALL GRASSED AREAS, OUTSIDE THE LIMITS OF THE SITE, DISTURBED BY THE CONTRACTOR SHALL BE REINSTATED WITH 100mm TOPSOIL AND SO₂.
 4. FINISHED LOT GRADING WILL NOT ADVERSELY AFFECT DRAINAGE PATTERNS OF ADJACENT LANDS.
 5. ALL WORKS WITHIN THE MUNICIPAL R.O.W. REQUIRES A ROAD OCCUPANCY PERMIT.
 6. CULVERTS TO BE HDPE SMOOTH INSIDE WALL WITH GRANULAR 'A' BEDDING, COVER AND BACKFILL.

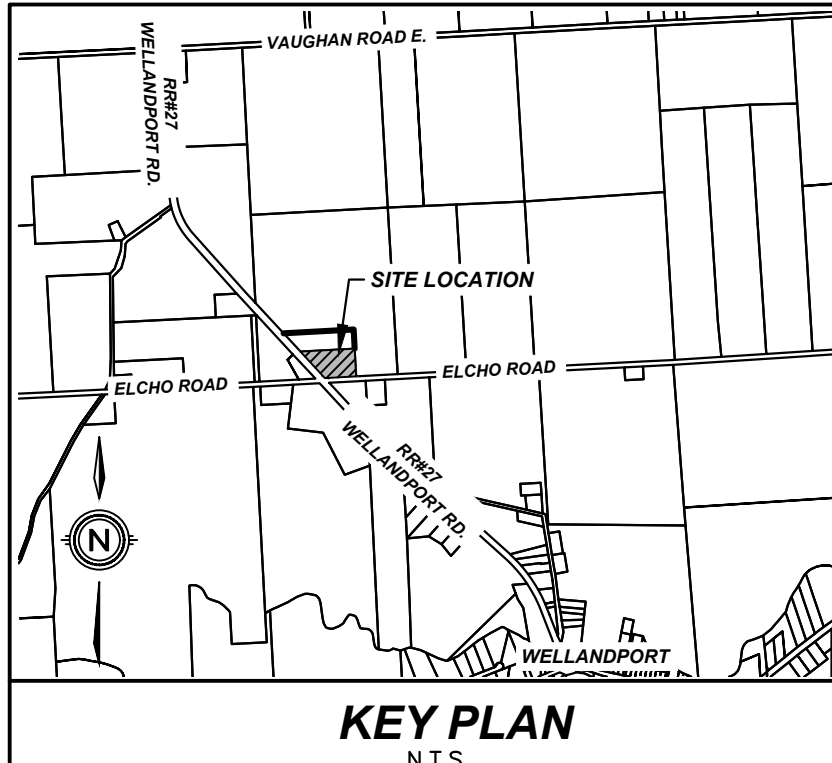

LEGEND

WV ⊙	EX WATER VALVE
WV ●	PROP WATER VALVE
WVC ○	EX WATER VALVE CHAMBER
WMC ○	PROP WATER METER CHAMBER
HYD ○	EX HYDRANT
HYD ●	PROP HYDRANT
CB □	EX CATCHBASIN
CB ■	PROP CATCHBASIN
DCB □	EX DOUBLE CATCHBASIN
DCB ■	PROP DOUBLE CATCHBASIN
CBMH ○	EX CATCHBASIN MANHOLE
CBMH ●	PROP CATCHBASIN MANHOLE
STM ○	EX STORM MANHOLE
MH ●	PROP STORM MANHOLE
SAN ○	EX SANITARY MANHOLE
MH ●	PROP SANITARY MANHOLE
PLUG ⊔	EX PLUG
PLUG ⊔	PROP PLUG
HP ⊔	PROP COMMUNITY MAILBOX
HP ⊔	EX HYDRO POLE
TRANS ⊔	PROP HYDRO TRANSFORMER
SL PED ●	PROP STREET LIGHT PEDESTAL
LS ⊕	EX LIGHT STANDARD
LS ⊕	PROP LIGHT POLE
DOOR ⊔	EX DOOR
DOOR ⊔	PROP WOOD FENCE
PERMANTANT ROCK CHECK DAM	PERMANTANT ROCK CHECK DAM
SILT FENCE	SILT FENCE

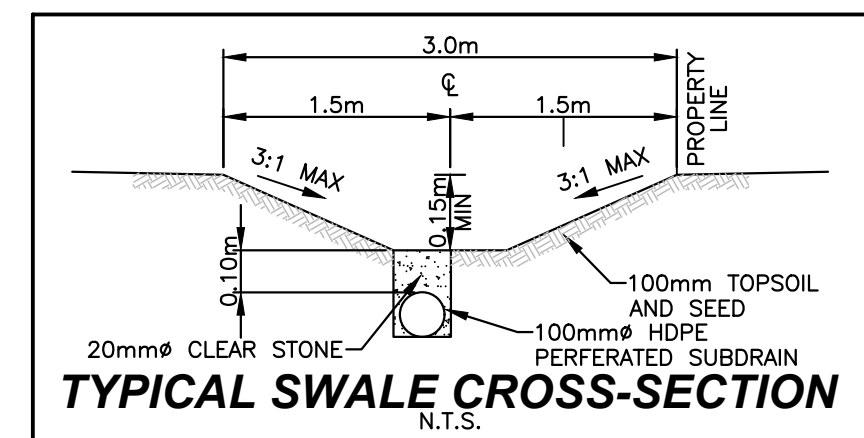
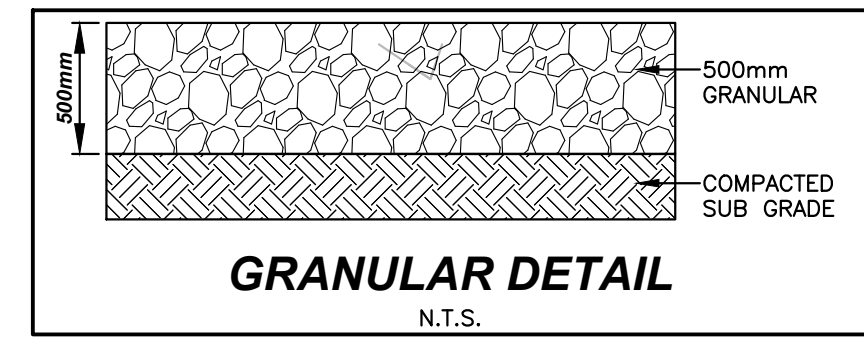
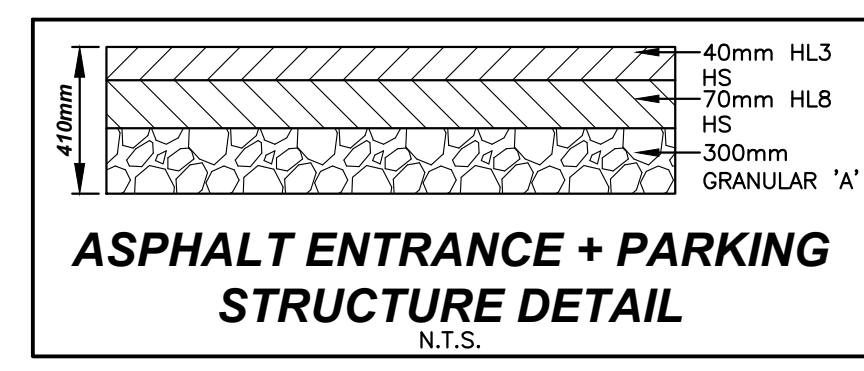

- NOTES:**
1. THE POSITION OF POLE LINES, CONDUITS, WATERMANS, SEWER, AND OTHER UNDERGROUND AND OVERGROUND UTILITIES AND STRUCTURES IS NOT NECESSARILY SHOWN ON THE CONTRACT DRAWINGS AND, WHERE SHOWN, THE ACCURACY OF THE POSITION OF SUCH UTILITIES AND STRUCTURES IS NOT GUARANTEED. BEFORE STARTING WORK, THE CONTRACTOR SHALL INFORM HIMSELF OF THE EXACT LOCATION OF ALL SUCH UTILITIES AND STRUCTURES AND SHALL ASSUME ALL LIABILITY FOR DAMAGE TO THEM.
 2. PROPERTY LINES WERE PLOTTED USING REGISTERED PLANS AND BARS LOCATED IN THE FIELD. TO VERIFY THE ACCURACY OF THESE PROPERTY LINES, A LEGAL SURVEY SHOULD BE PERFORMED PRIOR TO CONSTRUCTION.
 3. ALL CONSTRUCTION MUST COMPLY WITH THE NIAGARA PENINSULA STANDARD CONTRACT DOCUMENT.

DRAFTING	M.C.
DESIGN	J.S.
CHECKED BY	J.S.
APPROVED BY	

West Lincoln
Your Future Naturally

UPPER CANADA CONSULTANTS
ENGINEERS / PLANNERS

OWNER

ANTHONY AANTJES
5377 ELCHO ROAD
WEST LINCOLN, ON

**#5377 ELCHO ROAD (PHASE 2)
WELLANDPORT
GRADING PLAN**

CONSULTANT FILE No.	1736
DATE	2022-12-07
PRINTED	2022-12-07
SCALE	1:400 m
REF No.	
DWG No.	2189-GP
REV	0